

MODULE 0



Classic mechanical couplers 18 kg

Morin Original system coupler M0
for machines from 800kg to 2t
Couplers available on pages 18 to 30

Morin Original system tool summary - Module 0

Backhoes

Range 00	52
Range 01	53
Range 02	54

Banana buckets

58

Fixed ditch cleaning buckets

59

Range 00 and 01	59
Range 02	60

Tilt ditch cleaning buckets

61

Standard tools

62

Special tools

63

Bucket sets

65

Machines assigned to this module

BRAND	MACHINES	BUCKET RANGE	TINE CLASS
ACB+	REVERSIBLE KIT M0	-	-
AIRMAN	AX10u	01	D5
	AX17u	02	D5
AMMANN	AMX 12 AMX14	00	D5
	AMX 15SR AMX 18 AMX 18ZT AMX24-2	02	D5
BOBCAT	E08 E10 E10Z	00	D5
	E17 E17Z E19 E20 E20Z	02	D5
CASE	CX12D CX14D	00	D5
	CX17C/D CX18C/D CX19C/D CX20D CX22D	02	D5
CATERPILLAR	300.9D	01	D5
	301 (all models) 302CR-NG	02	D5
COLTRAX	CX10 CX12 [CX14	00	D5
	CX15 CX18 CX20	02	D5
DEVELON	DX10Z	00	D5
	DX17Z DX19	02	D5
EUROCOMACH	12ZT 14SR 15X	00	D5
	18ZT 19ZT 19TR 22SR	02	D5
HITACHI	ZX10U-6	01	D5
	ZX17U-6 ZX19U-6	02	D5
HYUNDAI	HX17A HX19A	02	D5
KATO IMER IHI	9VX3 9VXE HD09	01	D5
	12VX 12VXE HD12 17VXE 17VXT 17VX5 19VXT HD17	02	D5
JCB	8008 CTS 8010 CTS	01	D5
	16C-1 18Z 19C-1	02	D5
KATO IMER IHI	HD9VXE	01	D5

BRAND	MACHINES	BUCKET RANGE	TINE CLASS
KATO IMER IHI	HD12VXE HD17VXE	02	D5
KOBELCO	SK08 SK08-1E	00	D5
	SK10SR-2E SK16 SK18 SK17SR-3E	02	D5
KOMATSU	PC09-1	01	D5
	PC16R-3	02	D5
KUBOTA	K008-5 U10-5	01	D5
	KX016-4 KX019-4 U15-3N U17-3a R310	02	D5
LIUGONG	CLG9018F	02	D5
MESSERSI	M-13K M-16U M-18DS	02	D5
NEW-HOLLAND	E12D E14D E16B E18B E17D E18D E19D E20D	02	D5
SANY	SY16C SY18C SY18U	02	D5
SUNWARD	SWE08B SWE17/F SWE18UB/UF SWE20F/FED SWE20B	02	D5
TAKEUCHI	TB210R	01	D5
	TB216 TB217R	02	D5
TEREX	TC10Z	01	D5
	TC15 TC16 TC19 TC20	02	D5
VOLVO	EC15E EC18E ECR18E EC20E	02	D5
WACKER-NEUSON	803	01	D5
	1404 2003RD ET16 ET18 ET20 EZ17 EZ17E	02	D5
XCMG	XE18E XE15E XE20E	02	D5
YANMAR	SV08 B08 Vio10-2A Vio12-2A SV15VT SV17VT SV19VT Vio17U	00	D5
		02	D5
YTO	SCOOP 19U	02	D5

BACKHOE RANGE 00

Morin Original system coupler MO
for machines from 800kg to 2t
Couplers available on pages 18 to 30

Specially designed for construction and renovation work, BACKHOE BUCKETS will satisfy your needs, whether you are working in a loose environment or a much more challenging one. They can be reinforced to withstand extreme conditions. So please don't hesitate to ask.

Profile PIN



DE365 17-7 Thickness 15 mm



Bucket with teeth

PART NUMBER	WIDTH (mm)	ISO CAPACITY (l)	BUCKET WEIGHT (kg)*	TOTAL WEIGHT (kg)	PRICE EXCL. VAT (€)	NUMBER OF TEETH	ITEM CODE
R00-200	200	9	17	33	-	2	5032229
R00-250	250	11	21	41	-	3	5031316
R00-300	300	14	22	47	-	3	5032230
R00-350	350	17	24	55	-	3	5050114
R00-400	400	20	27	63	-	4	5032231
R00-450	450	23	29	70	-	4	5031642
R00-500	500	26	31	78	-	4	5034076
R00-600	600	32	36	94	-	5	5031331

Thickness = Blade thickness | (*) Weight variation +/- 2% depending on equipment | Total weight = (ISO capacity in l x Density 1.8) + Bucket weight in kg
Average number of teeth

BACKHOE RANGE 01

Morin Original system coupler MO
for machines from 800kg to 2t
Couplers available on pages 18 to 30

Toothless bucket

PART NUMBER	WIDTH (mm)	ISO CAPACITY (l)	BUCKET WEIGHT (kg)*	TOTAL WEIGHT (kg)	PRICE EXCL. VAT (€)	ITEM CODE
R01-200	200	11	16	36	-	5022790
R01-250	250	14	19	44	-	5022796
R01-300	300	18	20	52	-	5022825
R01-350	350	21	22	60	-	5100713
R01-400	400	25	24	69	-	5045010
R01-450	450	29	27	79	-	5059201
R01-500	500	33	29	88	-	5054339

Profile PIN

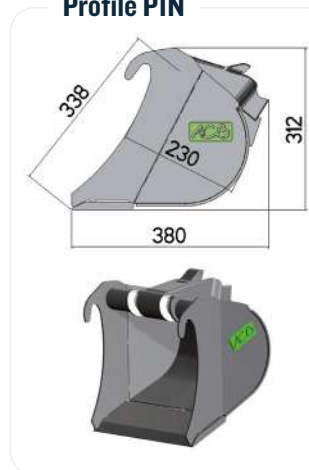

Profile PIN



Bucket with teeth

PART NUMBER	WIDTH (mm)	ISO CAPACITY (l)	BUCKET WEIGHT (kg)*	TOTAL WEIGHT (kg)	PRICE EXCL. VAT (€)	NUMBER OF TEETH	ITEM CODE	NUMBER OF TEETH	ITEM CODE	NUMBER OF TEETH	ITEM CODE
R01-200	200	11	18	38	-	2	5032901	2	5100676	2	5100433
R01-250	250	14	22	47	-	3	5032853	2	5089201	3	5068313
R01-300	300	18	23	56	-	3	5034143	3	5100677	3	5085563
R01-350	350	21	26	64	-	3	5032854	3	5100678	3	5074217
R01-400	400	25	29	74	-	4	5034622	3	5089202	4	5068114
R01-450	450	29	31	83	-	4	5035686	4	5100683	4	5100707
R01-500	500	33	34	93	-	4	5035201	4	5100684	4	5070953

Thickness = Blade thickness | (*) Weight variation +/- 2% depending on equipment | Total weight = (ISO capacity in l x Density 1.8) + Bucket weight in kg | Average number of teeth

DE365 17-7 Thickness 15 mm



FEURST FKMCE Thickness 15 mm



FEURST M15 Thickness 15 mm



BACKHOE RANGE 02

Morin Original system coupler MO
for machines from 800kg to 2t
Couplers available on pages 18 to 30

Specially designed for construction and renovation work, BACKHOE BUCKETS will satisfy your needs, whether you are working in a loose environment or a much more challenging one. They can be reinforced to withstand extreme conditions. So please don't hesitate to ask.

Profile PIN



Toothless bucket

PART NUMBER	WIDTH (mm)	ISO CAPACITY (l)	BUCKET WEIGHT (kg)*	TOTAL WEIGHT (kg)	PRICE EXCL. VAT (€)	ITEM CODE
R02-200	200	15	22	49	-	5022366
R02-250	250	19	26	60	-	5022497
R02-300	300	24	28	71	-	5022361
R02-350	350	29	30	82	-	5022726
R02-400	400	34	33	94	-	5022739
R02-450	450	40	38	110	-	5022520
R02-500	500	45	40	121	-	5022744
R02-550	550	50	42	132	-	5022753
R02-600	600	55	46	145	-	5022760
R02-650	650	60	48	156	-	5022766
R02-700	700	66	51	170	-	5022583
R02-800	800	76	58	195	-	5093292

Thickness = Blade thickness | (*) Weight variation +/- 2% depending on equipment | Total weight = (ISO capacity in l x Density 1.8) + Bucket weight in kg

BACKHOE RANGE 02

Morin Original system coupler MO
for machines from 800kg to 2t
Couplers available on pages 18 to 30

Profile PIN



Bucket with teeth

REVERSIBLE BOLT-ON
COUNTER-BLADE
Thickness 20 mm



CATO 135-9390
Thickness 15 mm



COMBI MINI T29
Thickness 15 mm



DE365 17-7
Thickness 15 mm



ESCO V13SYL
Thickness 15 mm



PART NUMBER	WIDTH (mm)	ISO CAPACITY (l)	BUCKET WEIGHT (kg)*	TOTAL WEIGHT (kg)	PRICE EXCL. VAT (€)	NUMBER OF TEETH	ITEM CODE	NUMBER OF TEETH	ITEM CODE	NUMBER OF TEETH	ITEM CODE	NUMBER OF TEETH	ITEM CODE	NUMBER OF TEETH	ITEM CODE
R02-200	200	15	25	52	-	RBCB	5100849	2	5057357	2	5039226	2	5024002	2	5024065
R02-250	250	19	30	64	-	RBCB	5100850	3	5059232	2	5037421	3	5024318	2	5024058
R02-300	300	24	34	77	-	RBCB	5079787	3	5055982	3	5042446	3	5024138	3	5023992
R02-350	350	29	38	90	-	RBCB	5100851	3	5100722	3	5100780	3	5036683	3	5026095
R02-400	400	34	42	103	-	RBCB	5049694	4	5058139	4	5043849	4	5024662	3	5024059
R02-450	450	40	46	118	-	RBCB	5074955	4	5067630	4	5037422	4	5024139	4	5024066
R02-500	500	45	51	132	-	RBCB	5035688	4	5059233	4	5040630	4	5024129	4	5023993
R02-550	550	50	54	144	-	RBCB	5100852	4	5100724	4	5044609	4	5100751	4	5028127
R02-600	600	55	59	158	-	RBCB	5037794	5	5055983	4	5037423	5	5032835	4	5024060
R02-650	650	60	62	170	-	RBCB	5028814	5	5100725	5	5100781	5	5100752	5	5038457
R02-700	700	66	66	185	-	RBCB	5100853	5	5100737	5	5100782	6	5022587	5	5031129
R02-800	800	76	75	212	-	RBCB	5100854	6	5100738	6	5100783	6	5051214	6	5040736

Thickness = Blade thickness | (*) Weight variation +/- 2% depending on equipment | Total weight = (ISO capacity in l x Density 1.8) + Bucket weight in kg | Average number of teeth | Stock item

BACKHOE RANGE 02

Morin Original system coupler MO
for machines from 800kg to 2t
Couplers available on pages 18 to 30

Specially designed for construction and renovation work, BACKHOE BUCKETS will satisfy your needs, whether you are working in a loose environment or a much more challenging one. They can be reinforced to withstand extreme conditions. So please don't hesitate to ask.

Profile PIN

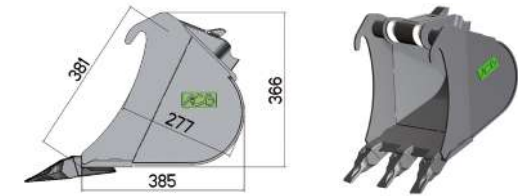

Bucket with teeth

FEURST 20C
Thickness 15 mm



FEURST FK1TLR
Thickness 15 mm



FEURST FKMCE
Thickness 15 mm



FEURST M15
Thickness 15 mm



PART NUMBER	WIDTH (mm)	ISO CAPACITY (l)	BUCKET WEIGHT (kg)*	TOTAL WEIGHT (kg)	PRICE EXCL. VAT (€)	NUMBER OF TEETH	ITEM CODE	NUMBER OF TEETH	ITEM CODE	NUMBER OF TEETH	ITEM CODE	NUMBER OF TEETH	ITEM CODE
R02-200	200	15	26	53	-	2	5030914	2	5039530	2	5051233	2	5073802
R02-250	250	19	32	66	-	2	5024475	2	5037896	3	5052668	3	5068314
R02-300	300	24	34	77	-	3	5028348	3	5037342	3	5045014	3	5073464
R02-350	350	29	37	89	-	3	5027867	3	5044933	3	5082114	3	5100712
R02-400	400	34	40	101	-	3	5029406	3	5037897	3	5080612	4	5068315
R02-450	450	40	45	117	-	3	5024476	3	5037341	4	5045013	4	5072464
R02-500	500	45	49	130	-	4	5033360	4	5039720	4	5064530	4	5070954
R02-550	550	50	51	141	-	4	5100715	4	5051749	4	5070728	4	5100708
R02-600	600	55	55	154	-	4	5025550	4	5038620	4	5067217	5	5100709
R02-650	650	60	57	165	-	4	5100716	4	5100756	4	5100686	5	5100710
R02-700	700	66	64	183	-	5	5100717	5	5100757	6	5082480	6	5100711
R02-800	800	76	69	206	-	5	5061036	5	5100758	5	5100687	6	M15

Thickness = Blade thickness | (*) Weight variation +/- 2% depending on equipment | Total weight = (ISO capacity in l x Density 1.8) + Bucket weight in kg | Average number of teeth

BACKHOE RANGE 02

Morin Original system coupler MO
for machines from 800kg to 2t
Couplers available on pages 18 to 30

Profile PIN

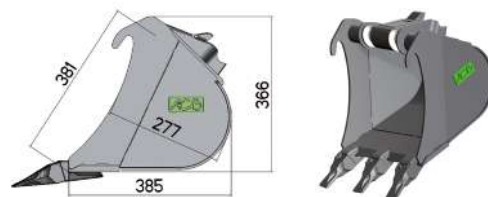

Bucket with teeth

PART NUMBER	WIDTH (mm)	ISO CAPACITY (l)	BUCKET WEIGHT (kg)*	TOTAL WEIGHT (kg)	PRICE EXCL. VAT (€)	NUMBER OF TEETH	ITEM CODE	NUMBER OF TEETH	ITEM CODE
R02-200	200	15	25	52	-	2	5100766	2	5026536
R02-250	250	19	29	63	-	2	5082518	2	5024481
R02-300	300	24	33	76	-	3	5080872	3	5025135
R02-350	350	29	35	87	-	3	5085277	3	5029404
R02-400	400	34	38	99	-	3	5088247	3	5024723
R02-450	450	40	44	116	-	4	5080873	4	5025133
R02-500	500	45	47	128	-	4	5082143	4	5025738
R02-550	550	50	49	139	-	4	5100767	4	5036293
R02-600	600	55	53	152	-	4	5088249	4	5025136
R02-650	650	60	57	165	-	4	5100768	5	MG5L
R02-700	700	66	60	179	-	5	5100769	5	5084291
R02-800	800	76	68	205	-	6	5100770	6	5034333

Thickness = Blade thickness | (*) Weight variation +/- 2% depending on equipment | Total weight = (ISO capacity in l x Density 1.8) + Bucket weight in kg | Average number of teeth

FUTURA FT130S

Thickness 15 mm



MTG MG5L

Thickness 15 mm



BANANA BUCKETS

Morin Original system coupler MO for machines from 800kg to 2t
Couplers available on pages 18 to 30

Thanks to its narrow width, the BANANA BUCKET is ideal for work requiring precision, such as small trenches or cable installation.

Profile 1

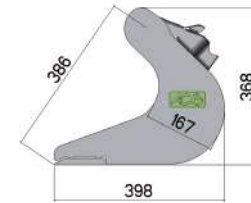

Profile 1

TOOTHLESS
Thickness 15 mm



DE365 17-7
Thickness 15 mm



ESCO V13SYL
Thickness 15 mm



FEURST FKITLR
Thickness 15 mm



PART NUMBER	WIDTH (mm)	ISO CAPACITY (l)	BUCKET WEIGHT (kg)*	TOTAL WEIGHT (kg)	PRICE EXCL. VAT (€)	ITEM CODE	PRICE EXCL. VAT (€)	NUMBER OF TEETH	ITEM CODE	PRICE EXCL. VAT (€)	NUMBER OF TEETH	ITEM CODE	PRICE EXCL. VAT (€)	NUMBER OF TEETH	ITEM CODE
02GL-1-200	200	11	21	41	-	5002452	-	2	5141040	-	2	5147005	-	2	5092410
02GL-1-250	250	13	25	48	-	5007442	-	3	5031030	-	2	5031025	-	2	5038369

Profile 2

TOOTHLESS
Thickness 15 mm



REVERSIBLE BOLT-ON COUNTER-BLADE
Thickness 15 mm



PART NUMBER	WIDTH (mm)	ISO CAPACITY (l)	BUCKET WEIGHT (kg)*	TOTAL WEIGHT (kg)	PRICE EXCL. VAT (€)	ITEM CODE	BUCKET WEIGHT (kg)*	TOTAL WEIGHT (kg)	PRICE EXCL. VAT (€)	ITEM CODE
02GL-2-200	200	14	24	49	-	5002265	30	55	-	5129355
02GL-2-250	250	17	28	59	-	5005334	34	65	-	5079758

Profile 2

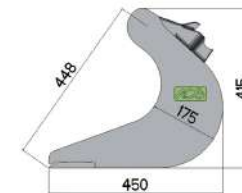

Thickness = Blade thickness | (*) Weight variation +/- 2% depending on equipment | Total weight = (ISO capacity in l x Density 1.8) + Bucket weight in kg | Average number of teeth

FIXED DITCH CLEANING BUCKETS RANGE 00 AND 01

Morin Original system coupler MO for machines from 800kg to 2t
Couplers available on pages 18 to 30

The DITCH CLEANING BUCKET can be used for finishing work such as ditch cleaning, embanking, levelling and much more.

Thickness = Blade thickness | (*) Weight variation of +/- 2% depending on equipment | Total weight = (ISO capacity in l x Density 1.8) + Bucket weight in kg |

Stock item ■

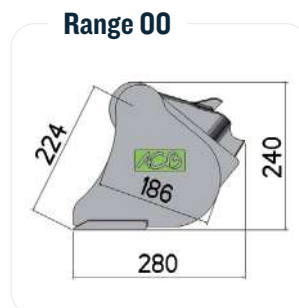
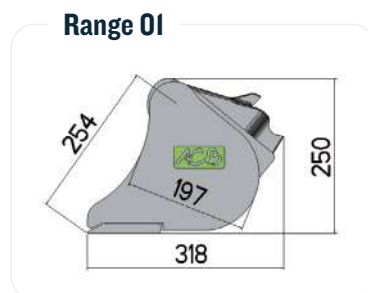

Range 00

PART NUMBER	WIDTH (mm)	ISO CAPACITY (l)	BUCKET WEIGHT (kg)*	TOTAL WEIGHT (kg)	PRICE EXCL. VAT (€)	ITEM CODE	BUCKET WEIGHT (kg)*	TOTAL WEIGHT (kg)	PRICE EXCL. VAT (€)	ITEM CODE
CM00-600	600	23	26	67	-	5036341	39	80	-	5112516
CM00-750	750	30	30	84	-	5057030	43	97	-	RBCB
CM00-800	800	31	32	88	-	5066219	45	101	-	5100081
CM00-1000	1000	39	39	109	-	5060717	52	122	-	5125583



Range 01

PART NUMBER	WIDTH (mm)	ISO CAPACITY (l)	BUCKET WEIGHT (kg)*	TOTAL WEIGHT (kg)	PRICE EXCL. VAT (€)	ITEM CODE	BUCKET WEIGHT (kg)*	TOTAL WEIGHT (kg)	PRICE EXCL. VAT (€)	ITEM CODE
CM01-600	600	27	27	76	-	5002698	40	89	-	5063917
CM01-700	700	33	29	88	-	5023653	42	103	-	5115795
CM01-800	800	37	33	100	-	5002663	46	116	-	5042573
CM01-1000	1000	47	40	125	-	5002699	60	145	-	5050751



FIXED DITCH CLEANING BUCKETS RANGE 02

Morin Original system coupler MO
for machines from 800kg to 2t
Couplers available on pages 18 to 30

The DITCH CLEANING BUCKET can be used
for finishing work such as ditch cleaning,
embanking, levelling and much more.

Thickness = Blade thickness | (*) Weight variation of +/- 2%
depending on equipment | Total weight = (ISO capacity in l x
Density 1.8) + Bucket weight in kg |

Stock item ■

Range 02 - Ditch cleaning buckets

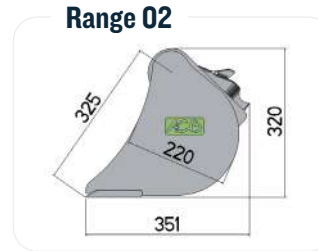

PART NUMBER	WIDTH (mm)	ISO CAPACITY (l)	BUCKET WEIGHT (kg)*	TOTAL WEIGHT (kg)	PRICE EXCL. VAT (€)	ITEM CODE	BUCKET WEIGHT (kg)*	TOTAL WEIGHT (kg)	PRICE EXCL. VAT (€)	ITEM CODE
CM0-600	600	43	35	112	-	5043152	47	124	-	5131783
CM0-700	700	51	39	131	-	5037917	53	145	-	RBCB
CM0-800	800	58	42	146	-	5001377	60	164	-	5061018
CM0-850	850	62	46	158	-	5001378	63	175	-	5138991
CM0-1000	1000	74	51	184	-	5001380	72	205	-	5013046
CM0-1100	1100	81	55	201	-	5017294	78	224	-	5124010
CM0-1200	1200	89	60	220	-	5001381	84	244	-	5045463

TILT DITCH CLEANING BUCKETS

Morin Original system coupler M0 for machines from 800kg to 2t
Couplers available on pages 18 to 30

The TILT DITCH CLEANING BUCKET can be used for finishing work such as ditch cleaning, embanking, levelling and much more. The tilting version is stable on the ground and remains upright to facilitate the next attachment.

Thickness = Blade thickness | (*) Weight variation +/- 2% depending on equipment | Total weight = (ISO capacity in l x Density 1.8) + Bucket weight in kg | Stock item

Retaining kit

Optional retaining kits are available to compensate for hydraulic leaks and keep the tilt ditch cleaning bucket in the desired position.

MODULE	ITEM CODE	PRICE EXCL. VAT (€)
M0	5086889	-

Range 00 and 01 - Tilt ditch cleaning buckets Profile OIPO (2 x 45° - 1 Cylinder)

Range 02 - Profile OIPI

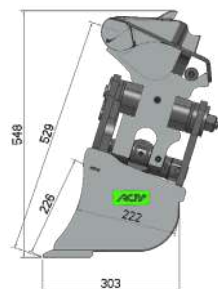

SMOOTH BLADE

Thickness 15 mm



REVERSIBLE BOLT-ON COUNTER-BLADE

Thickness 20 mm



PART NUMBER	WIDTH (mm)	ISO CAPACITY (l)	BUCKET WEIGHT (kg)*	TOTAL WEIGHT (kg)	PRICE EXCL. VAT (€)	ITEM CODE	BUCKET WEIGHT (kg)*	TOTAL WEIGHT (kg)	PRICE EXCL. VAT (€)	ITEM CODE
OIPO-1000	1000	47	80	165	-	5168374	101	186	-	RBCB

Range 02 - Tilt ditch cleaning buckets Profile OIPI (2 x 45° - 1 Cylinder)

Range 02 - Profile OIPI

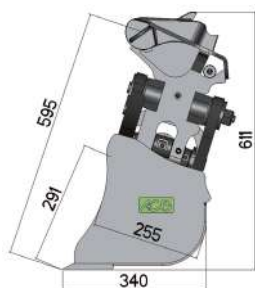

SMOOTH BLADE

Thickness 15 mm



REVERSIBLE BOLT-ON COUNTER-BLADE

Thickness 20 mm



PART NUMBER	WIDTH (mm)	ISO CAPACITY (l)	BUCKET WEIGHT (kg)*	TOTAL WEIGHT (kg)	PRICE EXCL. VAT (€)	ITEM CODE	BUCKET WEIGHT (kg)*	TOTAL WEIGHT (kg)	PRICE EXCL. VAT (€)	ITEM CODE
OIPI-1000	1000	74	106	239	-	5087491	127	260	-	5100187

STANDARD TOOLS

Morin Original system coupler MO
for machines from 800kg to 2t
Couplers available on pages 18 to 30

As a bucket isn't always enough, a range of tools is available to meet all your needs. For more information, please refer to the attached product specification sheets or contact us

(*) Weight variation of +/- 2% depending on equipment |
Stock item ■

Trapezoidal bucket with 65° angles

Bucket for creating profiled ditches

Dimensions:

- Large base (GB) = 760 mm
- Beam height (HSP) = 450 mm
- Small base (PB) = 200 mm
- Teeth can be welded on request



PART NUMBER	WEIGHT (kg)*	PRICE EXCL. VAT (€)
TMP-MO	70	-

Suspension link

Tool for single-axis articulation of products already fitted with a suspension system

Diameter 40 mm x Width 90 mm



PART NUMBER	WEIGHT (kg)*	PRICE EXCL. VAT (€)
5007985	17	-

Universal joint

Tool for articulating, along two axes, a gripper, a grapple, an auger, etc.

PART NUMBER	WEIGHT (kg)*	PRICE EXCL. VAT (€)
UNIVERSAL JOINT-MO	Depending on equipment	-



Ripper tooth

Ripper tooth for work on rocky terrain
R = 610 40 mm 1 tooth ESCO 18TL



PART NUMBER	WEIGHT (kg)*	PRICE EXCL. VAT (€)
5028133	25	-

Pin-on adapter

Tool for pinning your hydraulic equipment using two pins



PART NUMBER	WEIGHT (kg)*	PRICE EXCL. VAT (€)
PIN-ON ADAPTER-MO	Depending on size	-

Bolt-on adapter

Tool for bolting on hydraulic equipment



PART NUMBER	WEIGHT (kg)*	PRICE EXCL. VAT (€)
BOLT-ON ADAPTER-MO	Depending on equipment	-

ITEM CODE	BRANDS
5002213	BOBCAT: HB580 HB380 B300 DOOSAN: DA120 MONTABERT: 95/95HD 85/85HD 30/50/70 SC8 SC12 NEUSON: NE8 NE12
5038484	EPIROC: SB102 SB100-MK2 HC150 ATLASCOPCO: HC103 KUBOTA: KM105
5045065	EPIROC: SB55 SB52 MG100 KUBOTA: KM55

SPECIAL TOOLS

Morin Original system coupler MO
Version V4.0 for machines from 800kg to 2t
Couplers available on pages 18 to 30

Non-exhaustive list. Please contact us for more information.

Some situations require special dimensions or configurations. That's why ACB+ is at your disposal for any specific requests. Our SPECIAL TOOLS are made to measure. So you have a choice of teeth, pitch, width, etc. Here are just a few examples.

(*) Weight variation of +/- 2% depending on equipment

Grid backhoe

Tool for sieving rubble and pebbles.
Grid backhoe Range 02 - 600 mm
5 teeth ESCO V13SYL - Pitch 60 x 60 mm



PART NUMBER	WEIGHT (kg)*	PRICE EXCL. VAT (€)
5058256	55	-

Cemetery bucket

Wide-opening bucket to optimise vertical digging close to the machine
Cemetery Bucket Range 02 - 400 mm
4 teeth FEURST M15 - 0.028m3 - Pitch 100 mm



PART NUMBER	WEIGHT (kg)*	PRICE EXCL. VAT (€)
5068967	35	-

Grid ditch cleaning bucket

Tool for small jobs sorting materials on the ground over a broad strip.
Grid ditch cleaning bucket Range 02 - 1,000 mm
Pitch 50 x 120 mm - Profile without blade or sidewall



PART NUMBER	WEIGHT (kg)*	PRICE EXCL. VAT (€)
5090171	50	-

Tool for sorting loose materials containing pebbles
Grid ditch cleaning bucket 960 mm
Pitch 80 x 100 mm - 8 Teeth MTG MG5V
Scalloped blade



PART NUMBER	WEIGHT (kg)*	PRICE EXCL. VAT (€)
5094195	82	-

SPECIAL TOOLS

Morin Original system coupler MO
for machines from 800kg to 2t
Couplers available on pages 18 to 30

(*) Weight variation of +/- 2 % depending on equipment | Average number of teeth

Rake

A tool for small-scale landscape finishing work, such as grading and sorting materials on the ground, etc. 1200 mm rake - Pitch 60 mm



PART NUMBER	WEIGHT (kg)*	PRICE EXCL. VAT (€)
5082814	50	-

Stump grinder tooth

Tool for levelling (cutting) stumps and completing stump removal
Stump grinder -
R = 500 - 40 mm



PART NUMBER	WEIGHT (kg)*	PRICE EXCL. VAT (€)
5100826	32	-

Front and rear rake

Tool for small forestry jobs to create swaths by pulling and pushing
Front and Rear Rake
550 mm 6 Claws - Pitch 73 mm



PART NUMBER	WEIGHT (kg)*	PRICE EXCL. VAT (€)
5093763	86	-

Claw backhoe

Tool for gripping and manipulating objects -
Claw backhoe 500 mm
0.045m³ - 4 Teeth ESCO
V13SYL



PART NUMBER	WEIGHT (kg)*	PRICE EXCL. VAT (€)
5104195	76	-

BUCKET SETS - EXPRESS OPTION

DELIVERED WITHIN 5 WORKING DAYS

Morin Original system coupler MO | for machines from 800kg to 2t | Couplers available on pages 18 to 30

To save time and increase convenience, ACB+ stocks palletised bucket sets. These consist of two earthmoving buckets and one ditch cleaning bucket selected from the most popular sizes.

(*) Weight variation of +/- 2% depending on equipment

(**) Depending on availability | Stock item ■

Bucket set range 01



Bucket set range 01



ITEM CODE	CONTAINER	DESIGNATION	TEETH	WEIGHT (kg)*	PRICE EXCL. VAT (€)	BUCKET SET + COUPLER MOS**
5073717	5032901	1 BACKHOE Range 01 - Width 200 mm	DE365 17-7	104	-	-
	5034622	1 BACKHOE Range 01 - Width 400 mm				
	5002663	1 DITCH CLEANING BUCKET Range 01 - Width 800 mm				

Narrow bucket set Range 02



Narrow bucket set Range 02



ITEM CODE	CONTAINER	DESIGNATION	TEETH	WEIGHT (kg)*	PRICE EXCL. VAT (€)	BUCKET SET + COUPLER MOS**
5073718	5024058	1 backhoe Range 02 - Width 250 mm	ESCO V13SYL	149	-	-
	5024066	1 backhoe Range 02 - Width 450 mm				
	5001380	1 DITCH CLEANING BUCKET Range 02 - Width 1,000 mm				

BUCKET SETS - EXPRESS OPTION

DELIVERED WITHIN 5 WORKING DAYS

Morin Original system coupler MO | for machines from 800kg to 2t | Couplers available on pages 18 to 30

Wide bucket set range 02



Wide bucket set range 02



ITEM CODE	CONTAINER	DESIGNATION	TEETH	WEIGHT (kg)*	PRICE EXCL. VAT (€)	BUCKET SET + COUPLER MOS**
5073719	5023992	1 backhoe Range 02 - Width 300 mm	ESCO V13SYL	155	-	-
	5023993	1 backhoe Range 02 - Width 500 mm				
	5001380	1 DITCH CLEANING BUCKET Range 02 - Width 1,000 mm				

(*) Weight variation of +/- 2% depending on equipment

(**) Depending on availability | Stock item ■