

# MODULE 1



Classic mechanical couplers 35 kg



Classic hydraulic couplers 44 kg

**Morin Original system coupler M1**  
for machines from 2t to 3.5t  
Couplers available on pages 18 to 30

## Morin Original system tool summary - Module 1

<b>Backhoes</b>	<b>68</b>
Range 12	68
Range 13	71
<b>Banana buckets</b>	<b>75</b>
<b>Fixed ditch cleaning buckets</b>	<b>77</b>
<b>Tilt ditch cleaning buckets</b>	<b>79</b>
<b>Standard tools</b>	<b>80</b>
<b>Special tools</b>	<b>81</b>
<b>Bucket sets</b>	<b>83</b>

Hydraulic kit for powering and controlling hydraulic coupler 5163582. **More information on page 43.**

## Machines assigned to this module

BRAND	MACHINES	BUCKET RANGE	TINE CLASS
ACB+	REVERSIBLE KIT M1	-	-
AIRMAN	AX27U-5F	13	D5
AMMANN	AMX 22SR   AMX24   AMX 25ZT   AMX28   AMX 28ZT   AMX 35ZT	12	D5
BOBCAT	E25   E26   E27   E27Z   E32   E34   E35   E35Z   E37	12	D5
CASE	CX28D   CX35D	12	D5
	CX26C   CX30C   CX37C	13	D5
CATERPILLAR	302.2D   302.4D   302.5C   302.7   302.7D   302.7NG	12	D5
	303 (all models)   304E2-CR	13	D5
COLTRAX	CX22   CX25   CX28   CX35	12	D5
DEVELON	DX27Z   DX27Z-7   DX35Z-7	12	D5
	DX30   DX35	13	D5
EUROCOMACH	25ZT   28ZT   35ZT	12	D5
EUROMACH	1500   R25	12	D5
	2500 MOBILE	13	D5
HIDROMEK	HMK62T   HMK62SS	13	D5
HITACHI	ZX26U-6   ZX33U-6   ZX38U-6	13	D5
HYUNDAI	R25Z-9   R30Z-9A   R35Z-9	13	D5
JCB	2CX   3CX COMPACT   26C-1   25Z-1	12	D5
	35Z-1   36C-1	13	D5
KATO IMER IHI	HD27V5   HD33V5	12	D5
	HD37V5	13	D5
KOBELCO	SK25SR-6/E   SK26-1E   SK26SR-6/7   SK28SR-7   SK34SR-7   SK39SR-7	13	D5
KOMATSU	PC22MR-3   PC24MR-5   PC26MR-5	12	D5

BRAND	MACHINES	BUCKET RANGE	TINE CLASS
KUBOTA	KX027-4   U27-4   KX030-4   KX71-3   U20-3	12	D5
	KX037-4   U36-4	13	D5
LIUGONG	CLG9027F ZTS	12	D5
	CLG9035E ZTS	13	D5
MENZI-MUCK	A20	12	D5
MESSERSI	M22U   M25   M-28U   M-28K   M-35K   M-38U	12	D5
NEW-HOLLAND	E26BSR   E28D   E35D	12	D5
	E26C   E27-2SR   E29BSR   E35SR/BSR   E39BSR   E37C	13	D5
SANY	SY26U   SY35U	13	D5
SUNWARD	SWE25UF	12	D5
	SWE35UF	13	D5
TAKEUCHI	TB225   TB230   TB325R	12	D5
	TB235-2   TB240   TB335R	13	D5
TEREX	TC25   TC29	12	D5
VENIERI	1.33B	12	D5
VOLVO	EC27D   ECR25D	12	D5
WACKER-NEUSON	2404   2503   ET24   EZ26	12	D5
	ET35   EZ36   EZ38	13	D5
XCMG	XE35E   XE35U	12	D5
YANMAR	Vio23-6   Vio38-6	12	D5
	SV26   Vio25-4   Vio26-6   Vio27-6   Vio33U   Vio38U	13	D5
YUCHAI	YC35-SR	13	D5

# BACKHOE RANGE 12

Morin Original system coupler MI  
for machines from 2t to 3.5t  
Couplers available on pages 18 to 30

Specially designed for construction and renovation work, BACKHOE BUCKETS will satisfy your needs, whether you are working in a loose environment or a much more challenging one. They can be reinforced to withstand extreme conditions. So please don't hesitate to ask.

## Profile PIN



## Toothless bucket

PART NUMBER	WIDTH (mm)	ISO CAPACITY (l)	BUCKET WEIGHT (kg)*	TOTAL WEIGHT (kg)	PRICE EXCL. VAT (€)	ITEM CODE
R12-260	260	30	38	92	-	5019969
R12-300	300	36	42	107	-	5020072
R12-350	350	44	44	123	-	5020103
R12-400	400	52	50	144	-	5020107
R12-450	450	61	54	164	-	5020116
R12-500	500	70	58	184	-	5020121
R12-550	550	78	62	202	-	5020132
R12-600	600	86	65	220	-	5019904
R12-650	650	95	70	241	-	5020144
R12-700	700	103	74	259	-	5020155
R12-750	750	112	77	279	-	5020161
R12-800	800	120	89	305	-	5020169

(\*): Weight variation of +/- 2 % depending on equipment | Total weight = (ISO capacity in l x Density 1.8) + Bucket weight in kg

# BACKHOE RANGE 12

Morin Original system coupler MI  
for machines from 2t to 3.5t  
Couplers available on pages 18 to 30

## Profile PIN

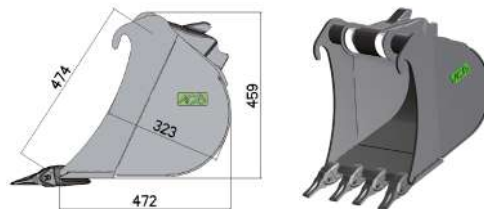

## Bucket with RBCB or teeth

**REVERSIBLE BOLT-ON  
COUNTER-BLADE**  
Thickness 20 mm



**CATO 135-9390**  
Thickness 15 mm



**COMBI MINI T29**  
Thickness 15 mm



**DE365 17-7**  
Thickness 15 mm



**ESCO V13SYL**  
Thickness 15 mm



PART NUMBER	WIDTH (mm)	ISO CAPACITY (l)	BUCKET WEIGHT (kg)*	TOTAL WEIGHT (kg)	PRICE EXCL. VAT (€)	NUMBER OF TEETH	ITEM CODE	NUMBER OF TEETH	ITEM CODE	NUMBER OF TEETH	ITEM CODE	NUMBER OF TEETH	ITEM CODE	NUMBER OF TEETH	ITEM CODE
R12-260	260	30	44	98	-	RBCB	5068620	3	5029765	3	5043895	3	5020835	3	5020715
R12-300	300	36	48	113	-	RBCB	5035689	3	5027102	3	5037418	3	5020805	3	5020729
R12-350	350	44	52	131	-	RBCB	5100827	3	5060530	3	5044608	3	5021452	3	5020731
R12-400	400	52	59	153	-	RBCB	5031485	4	5027346	3	5040301	4	5020878	3	5020734
R12-450	450	61	64	174	-	RBCB	5049451	4	5027103	4	5038871	4	5020812	4	5020735
R12-500	500	70	68	194	-	RBCB	5028981	4	5031811	4	5037416	4	5020808	4	5020739
R12-550	550	78	74	214	-	RBCB	5100830	4	5100739	4	5100785	4	5022345	4	5020742
R12-600	600	86	79	234	-	RBCB	5100831	5	5027347	4	5037912	5	5020830	4	5020743
R12-650	650	95	84	255	-	RBCB	5100832	5	5100740	5	5048431	5	5022880	5	5020754
R12-700	700	103	88	273	-	RBCB	5085849	5	5040737	5	5038872	6	5020908	5	5020756
R12-750	750	112	94	296	-	RBCB	5100833	6	5100741	6	5100784	5	5100755	6	5020762
R12-800	800	120	106	322	-	RBCB	5100835	6	5059605	6	5045395	6	5022646	6	5020763

Thickness = Blade thickness | (\*) Weight variation +/- 2% depending on equipment | Total weight = (ISO capacity in l x Density 1.8) + Bucket weight in kg | Stock item

# BACKHOE RANGE 12

Morin Original system coupler MI  
for machines from 2t to 3.5t  
Couplers available on pages 18 to 30

Specially designed for construction and renovation work, BACKHOE BUCKETS will satisfy your needs, whether you are working in a loose environment or a much more challenging one. They can be reinforced to withstand extreme conditions. So please don't hesitate to ask.

## Profile PIN

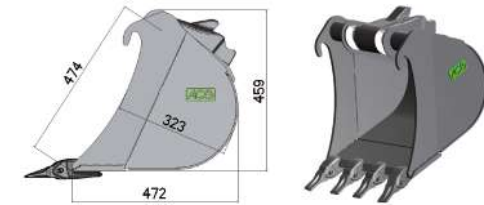

## Bucket with teeth

PART NUMBER	WIDTH (mm)	ISO CAPACITY (l)	BUCKET WEIGHT (kg)*	TOTAL WEIGHT (kg)	PRICE EXCL. VAT (€)	FEURST 20C Thickness 15 mm		FEURST FKITLR Thickness 15 mm		FUTURA FT130S Thickness 15 mm		MTG MG5L Thickness 15 mm		VOLVO 5GPC Thickness 15 mm	
						NUMBER OF TEETH	ITEM CODE	NUMBER OF TEETH	ITEM CODE	NUMBER OF TEETH	ITEM CODE	NUMBER OF TEETH	ITEM CODE	NUMBER OF TEETH	ITEM CODE
R12-260	260	30	47	101	-	3	5021347	3	5038048	2	5086293	3	5021395	3	5100804
R12-300	300	36	50	115	-	3	5021435	3	5037545	3	5075800	3	5020967	3	5100805
R12-350	350	44	57	136	-	3	5100718	3	5037610	3	5100771	3	5025813	3	5100806
R12-400	400	52	58	152	-	3	5022181	3	5042335	3	5088250	3	5025933	3	5100807
R12-450	450	61	62	172	-	3	5022285	3	5037546	4	5075801	4	5021198	3	5100809
R12-500	500	70	69	195	-	4	5021436	4	5037795	4	5077894	4	5021893	4	5100810
R12-550	550	78	73	213	-	4	5100720	4	5071820	4	5100772	4	5028097	4	5100811
R12-600	600	86	77	232	-	4	5021437	4	5037611	4	5085152	4	5020968	4	5100812
R12-650	650	95	81	252	-	4	5024962	4	5044859	5	5100773	5	5026408	4	5100813
R12-700	700	103	88	273	-	5	5023593	5	5041402	5	5085423	5	5021128	5	5100814
R12-750	750	112	92	294	-	5	5060123	5	5100759	5	5100774	5	5037062	5	5100816
R12-800	800	120	103	319	-	5	5035574	5	5042336	6	5100775	6	5024274	5	5100817

Thickness = Blade thickness | (\*) Weight variation +/- 2% depending on equipment | Total weight = (ISO capacity in l x Density 1.8) + Bucket weight in kg

# BACKHOE RANGE 13

Morin Original system coupler MI  
for machines from 2t to 3.5t  
Couplers available on pages 18 to 30

Profile PIN



## Toothless bucket

PART NUMBER	WIDTH (mm)	ISO CAPACITY (l)	BUCKET WEIGHT (kg)*	TOTAL WEIGHT (kg)	PRICE EXCL. VAT (€)	ITEM CODE
R13-260	260	42	42	118	-	5020495
R13-300	300	44	45	124	-	5020481
R13-350	350	54	48	145	-	5020472
R13-400	400	65	55	172	-	5020468
R13-450	450	75	59	194	-	5020460
R13-500	500	86	63	218	-	5020457
R13-550	550	96	68	241	-	5020451
R13-600	600	107	71	264	-	5019981
R13-650	650	118	76	288	-	5020408
R13-700	700	128	81	311	-	5020415
R13-750	750	139	84	334	-	5020422
R13-800	800	150	97	367	-	5020429

(\* Weight variation of +/- 2 % depending on equipment | Total weight = (ISO capacity in l x Density 1.8) + Bucket weight in kg

# BACKHOE RANGE I3

Morin Original system coupler MI  
for machines from 2t to 3.5t  
Couplers available on pages 18 to 30

Specially designed for construction and renovation work, BACKHOE BUCKETS will satisfy your needs, whether you are working in a loose environment or a much more challenging one. They can be reinforced to withstand extreme conditions. So please don't hesitate to ask.

## Profile PIN

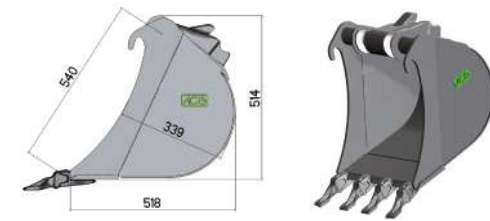

## Bucket with RBCB or teeth

PART NUMBER	WIDTH (mm)	ISO CAPACITY (l)	BUCKET WEIGHT (kg)*	TOTAL WEIGHT (kg)	PRICE EXCL. VAT (€)	REVERSIBLE BOLT-ON COUNTER-BLADE Thickness 20 mm		CATO 135-9390 Thickness 15 mm		COMBI MINI T29 Thickness 15 mm		DE365 17-7 Thickness 15 mm	
						NUMBER OF TEETH	ITEM CODE	NUMBER OF TEETH	ITEM CODE	NUMBER OF TEETH	ITEM CODE	NUMBER OF TEETH	ITEM CODE
R13-260	260	42	47	123	-	RBCB	5032964	3	5043486	3	5042342	3	5022100
R13-300	300	44	51	130	-	RBCB	5027593	3	5035071	3	5037419	3	5021995
R13-350	350	54	57	154	-	RBCB	5100836	3	5037909	3	5044426	3	5023481
R13-400	400	65	63	180	-	RBCB	5084292	4	5043487	3	5044541	4	5022433
R13-450	450	75	69	204	-	RBCB	5043547	4	5035072	4	5041141	4	5021996
R13-500	500	86	73	228	-	RBCB	5072654	4	5037910	4	5037628	4	5022694
R13-550	550	96	79	252	-	RBCB	5100837	4	5100747	4	5078061	4	5025325
R13-600	600	107	85	278	-	RBCB	5072057	5	5038400	4	5042470	5	5022103
R13-650	650	118	90	302	-	RBCB	5100838	5	5062670	5	5058148	5	5031385
R13-700	700	128	96	326	-	RBCB	5100839	5	5035073	5	5041155	6	5022627
R13-750	750	139	101	351	-	RBCB	5100842	6	5100748	6	5067563	6	5022252
R13-800	800	150	113	383	-	RBCB	5067504	6	5057098	5	5037420	6	5022434

Thickness = Blade thickness | (\*) Weight variation +/- 2% depending on equipment | Total weight = (ISO capacity in l x Density 1.8) + Bucket weight in kg

# BACKHOE RANGE 13

Morin Original system coupler MI  
for machines from 2t to 3.5t  
Couplers available on pages 18 to 30

## Profile PIN

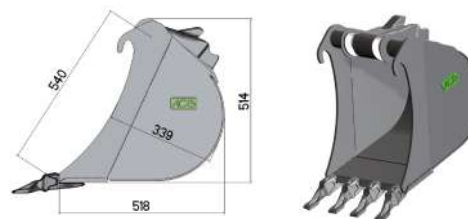

## Bucket with teeth

PART NUMBER	WIDTH (mm)	ISO CAPACITY (l)	BUCKET WEIGHT (kg)*	TOTAL WEIGHT (kg)	PRICE EXCL. VAT (€)	NUMBER OF TEETH	ITEM CODE	NUMBER OF TEETH	ITEM CODE	NUMBER OF TEETH	ITEM CODE	NUMBER OF TEETH	ITEM CODE
R13-260	260	42	50	126	-	3	5020765	2	5022695	3	5043840	3	5070947
R13-300	300	44	53	132	-	3	5021997	3	5022105	3	5041321	3	5080988
R13-350	350	54	58	155	-	3	5023361	3	5038115	3	5039122	3	5070948
R13-400	400	65	63	180	-	3	5022786	3	5022221	3	5041563	4	5070949
R13-450	450	75	68	203	-	4	5022311	3	5023184	3	5041322	4	5100858
R13-500	500	86	74	229	-	4	5021998	4	5022312	4	5045630	4	5070950
R13-550	550	96	79	252	-	4	5023359	4	5024422	4	5028200	4	5076039
R13-600	600	107	82	275	-	4	5022053	4	5022106	4	5039123	5	5070952
R13-650	650	118	87	299	-	5	5023360	4	5029386	4	5064510	5	5100859
R13-700	700	128	95	325	-	5	5022220	5	5022313	5	5042466	6	5100860
R13-750	750	139	99	349	-	6	5022424	5	5100721	5	5100760	6	5100861
R13-800	800	150	111	381	-	6	5022219	5	5029393	5	5045631	6	5100862

Thickness = Blade thickness | (\*) Weight variation +/- 2% depending on equipment | Total weight = (ISO capacity in l x Density 1.8) + Bucket weight in kg | Stock item

ESCO V13SYL  
Thickness 15 mm



FEURST 20C  
Thickness 15 mm



FEURST FKITLR  
Thickness 15 mm



FEURST M15  
Thickness 15 mm



# BACKHOE RANGE I3

Morin Original system coupler MI  
for machines from 2t to 3.5t  
Couplers available on pages 18 to 30

Specially designed for construction and renovation work, BACKHOE BUCKETS will satisfy your needs, whether you are working in a loose environment or a much more challenging one. They can be reinforced to withstand extreme conditions. So please don't hesitate to ask.

## Profile PIN

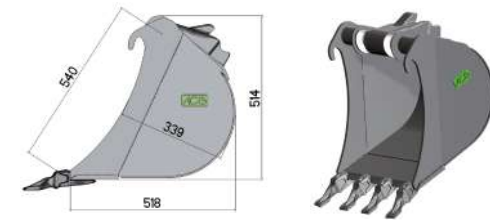

## Bucket with teeth

PART NUMBER	WIDTH (mm)	ISO CAPACITY (l)	BUCKET WEIGHT (kg)*	TOTAL WEIGHT (kg)	PRICE EXCL. VAT (€)	NUMBER OF TEETH	ITEM CODE	NUMBER OF TEETH	ITEM CODE	NUMBER OF TEETH	ITEM CODE
R13-260	260	42	49	125	-	3	5081713	3	5025324	3	5100818
R13-300	300	44	51	130	-	3	5081787	3	5021894	3	5064531
R13-350	350	54	56	153	-	3	5100776	3	5025812	3	5100819
R13-400	400	65	62	179	-	3	5084429	3	5023402	3	5076211
R13-450	450	75	68	203	-	4	5081715	4	5024305	3	5100820
R13-500	500	86	73	228	-	4	5086286	4	5021895	4	5100330
R13-550	550	96	76	249	-	4	5100777	4	5028201	4	5100821
R13-600	600	107	80	273	-	4	5081794	4	5022964	4	5100822
R13-650	650	118	85	297	-	4	5100778	5	5030908	4	5100823
R13-700	700	128	92	322	-	5	5090953	5	5021896	5	5100824
R13-750	750	139	96	346	-	5	5100779	6	5037353	5	5100825
R13-800	800	150	111	381	-	6	5082112	6	5024302	5	5064532

Thickness = Blade thickness | (\*) Weight variation +/- 2% depending on equipment | Total weight = (ISO capacity in l x Density 1.8) + Bucket weight in kg

FUTURA FT130S  
Thickness 15 mm



MTG MG5L  
Thickness 15 mm



VOLVO 5GPC  
Thickness 15 mm





# BANANA BUCKETS

Morin Original system coupler M1  
for machines from 2t to 3.5t  
Couplers available on pages 18 to 30

Thanks to its narrow width, the BANANA BUCKET is ideal for work requiring precision, such as small trenches or cable installation.

## Profile 1



### TOOTHLESS

Thickness 15 mm



### ESCO V13SYL

Thickness 15 mm



### FEURST FK1TLR

Thickness 15 mm



## Profile 1

PART NUMBER	WIDTH (mm)	ISO CAPACITY (l)	BUCKET WEIGHT (kg)*	TOTAL WEIGHT (kg)	PRICE EXCL. VAT (€)	ITEM CODE	PRICE EXCL. VAT (€)	NUMBER OF TEETH	ITEM CODE	PRICE EXCL. VAT (€)	NUMBER OF TEETH	ITEM CODE
1GL-1-200	200	13	41	64	-	5004087	-	2	5030616	-	2	5038397
1GL-1-250	250	17	45	76	-	5019212	-	2	5055622	-	2	5091217

### TOOTHLESS

Thickness 15 mm



### REVERSIBLE BOLT-ON COUNTER-BLADE

Thickness 15 mm



## Profile 2

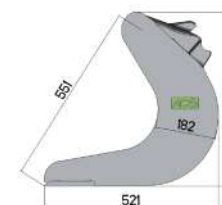

## Profile 2

PART NUMBER	WIDTH (mm)	ISO CAPACITY (l)	BUCKET WEIGHT (kg)*	TOTAL WEIGHT (kg)	PRICE EXCL. VAT (€)	ITEM CODE	BUCKET WEIGHT (kg)*	TOTAL WEIGHT (kg)	PRICE EXCL. VAT (€)	ITEM CODE
1GL-2-200	200	20	50	86	-	5052333	55	91	-	5120982
1GL-2-260	260	26	42	89	-	5002388	48	95	-	5007321
1GL-2-300	300	32	46	82	-	5003720	55	91	-	5130281

Thickness = Blade thickness | (\*) Weight variation +/- 2% depending on equipment | Total weight = (ISO capacity in l x Density 1.8) + Bucket weight in kg | Average number of teeth | Stock item

# BANANA BUCKETS

Morin Original system coupler MI  
for machines from 2t to 3.5t  
Couplers available on pages 18 to 30

Thanks to its narrow width, the BANANA BUCKET is ideal for work requiring precision, such as small trenches or cable installation.

Thickness = Blade thickness | (\*) Weight variation +/- 2% depending on equipment | Total weight = (ISO capacity in l x Density 1.8) + Bucket weight in kg | Average number of teeth | Stock item ■

## Profile 3

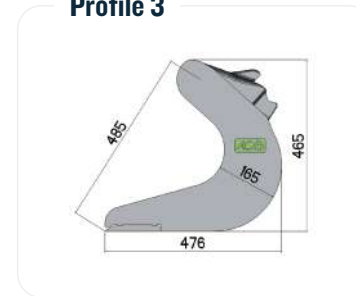

**TOOTHLESS**  
Thickness 15 mm



**ESCO V13SYL**  
Thickness 15 mm



## Profile 3

PART NUMBER	WIDTH (mm)	ISO CAPACITY (l)	BUCKET WEIGHT (kg)*	TOTAL WEIGHT (kg)	PRICE EXCL. VAT (€)	ITEM CODE	PRICE EXCL. VAT (€)	NUMBER OF TEETH	ITEM CODE
1GL-3-260	260	21	38	76	-	5002391	-	3	5145521
1GL-3-300	300	25	42	87	-	5003933	-	3	5031380

## Profile 4

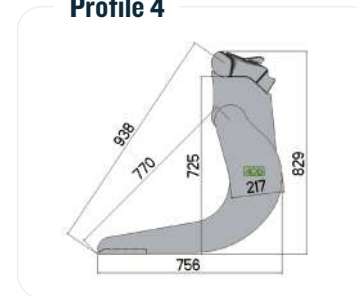

**TOOTHLESS**  
Thickness 15 mm



**ESCO V13SYL**  
Thickness 15 mm



## Profile 4

PART NUMBER	WIDTH (mm)	ISO CAPACITY (l)	BUCKET WEIGHT (kg)*	TOTAL WEIGHT (kg)	PRICE EXCL. VAT (€)	ITEM CODE	PRICE EXCL. VAT (€)	NUMBER OF TEETH	ITEM CODE
1GL-4-200	200	28	68	118	-	5037159	-	3	V13SYL

# FIXED DITCH CLEANING BUCKETS

Morin Original system coupler MI for machines from 2t to 3.5t  
Couplers available on pages 18 to 30

The DITCH CLEANING BUCKET can be used for finishing work such as ditch cleaning, embanking, levelling and much more.

Thickness = Blade thickness | (\*) Weight variation +/- 2% depending on equipment | Total weight = (ISO capacity in l x Density 1.8) + bucket weight in kg | Stock item ■

Profile P2



Profile P1



SMOOTH BLADE

Thickness 15 mm



REVERSIBLE BOLT-ON COUNTER-BLADE

Thickness 20 mm



Profile P1

PART NUMBER	WIDTH (mm)	ISO CAPACITY (l)	BUCKET WEIGHT (kg)*	TOTAL WEIGHT (kg)	PRICE EXCL. VAT (€)	ITEM CODE	BUCKET WEIGHT (kg)*	TOTAL WEIGHT (kg)	PRICE EXCL. VAT (€)	ITEM CODE
CM1-1000	1000	99	70	248	-	5001384	90	268	-	5017012
CM1-1200	1200	121	79	297	-	5001386	105	323	-	5004321
CM1-1300	1300	131	84	320	-	5001387	112	348	-	5034728
CM1-1400	1400	141	89	343	-	5001388	119	373	-	5028316
CM1-1500	1500	152	94	368	-	5001389	125	399	-	5082900

SMOOTH BLADE

Thickness 15 mm



REVERSIBLE BOLT-ON COUNTER-BLADE

Thickness 20 mm



Profile P2

PART NUMBER	WIDTH (mm)	ISO CAPACITY (l)	BUCKET WEIGHT (kg)*	TOTAL WEIGHT (kg)	PRICE EXCL. VAT (€)	ITEM CODE	BUCKET WEIGHT (kg)*	TOTAL WEIGHT (kg)	PRICE EXCL. VAT (€)	ITEM CODE
CM1-1000-P2	1000	141	87	341	-	5004489	109	363	-	5057582
CM1-1200-P2	1200	170	100	406	-	5001907	125	431	-	5035224
CM1-1300-P2	1300	186	106	441	-	5002475	134	469	-	5126559
CM1-1400-P2	1400	201	112	474	-	5002374	142	504	-	5067627
CM1-1500-P2	1500	216	118	507	-	5004791	163	552	-	5117259

# FIXED DITCH CLEANING BUCKETS

Morin Original system coupler M1  
for machines from 2t to 3.5t  
Couplers available on pages 18 to 30

The DITCH CLEANING BUCKET can be used for finishing work such as ditch cleaning, embanking, levelling and much more.

Thickness = Blade thickness | (\*) Weight variation +/- 2% depending on equipment | Total weight = (ISO capacity in l x Density 1.8) + Bucket weight in kg | Stock item ■

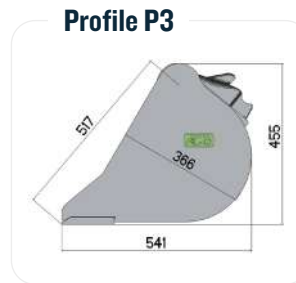

## Profile P3

PART NUMBER	WIDTH (mm)	ISO CAPACITY (l)	BUCKET WEIGHT (kg)*	TOTAL WEIGHT (kg)	PRICE EXCL. VAT (€)	ITEM CODE	BUCKET WEIGHT (kg)*	TOTAL WEIGHT (kg)	PRICE EXCL. VAT (€)	ITEM CODE
CM1-1000-P3	1000	170	97	403	-	5055439	127	433	-	5025336
CM1-1200-P3	1200	211	110	490	-	5004198	135	515	-	5059600
CM1-1400-P3	1400	248	124	570	-	5010759	153	599	-	5055803

### SMOOTH BLADE

Thickness 15 mm



### REVERSIBLE BOLT-ON COUNTER-BLADE

Thickness 20 mm



# TILT DITCH CLEANING BUCKETS

Morin Original system coupler M1  
for machines from 2t to 3.5t  
Couplers available on pages 18 to 30

The TILT DITCH CLEANING BUCKET can be used for finishing work such as ditch cleaning, embanking, levelling and much more. The tilting version is stable on the ground and remains upright to facilitate the next attachment.

Thickness = Blade thickness | (\*) Weight variation +/- 2% depending on equipment | Total weight = (ISO capacity in l x Density 1.8) + Bucket weight in kg | Stock item ■

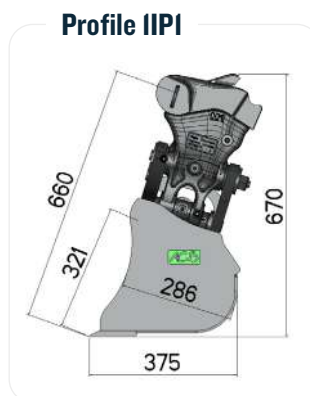

## Profile IIP1

PART NUMBER	WIDTH (mm)	ISO CAPACITY (l)	BUCKET WEIGHT (kg)*	TOTAL WEIGHT (kg)	PRICE EXCL. VAT (€)	ITEM CODE	BUCKET WEIGHT (kg)*	TOTAL WEIGHT (kg)	PRICE EXCL. VAT (€)	ITEM CODE
1IIP1-1200	1200	111	131	331	-	5086873	156	356	-	5090757

### SMOOTH BLADE

Thickness 15 mm



### REVERSIBLE BOLT-ON COUNTER-BLADE

Thickness 20 mm



## Retaining kit

Optional retaining kits are available to compensate for hydraulic leaks and keep the tilt ditch cleaning bucket in the desired position.

MODULE	ITEM CODE	PRICE EXCL. VAT (€)
M1	5086889	-

# STANDARD TOOLS

Morin Original system coupler M1 for machines from 2t to 3.5t  
Couplers available on pages 18 to 30

As a bucket isn't always enough, a range of TOOLS is available to meet all your needs. For more information, please refer to the attached product specification sheets or contact us.

(\*) Weight variation of +/- 2% depending on equipment | Stock item ■

## Trapezoidal bucket with 65° angles

Bucket for creating profiled ditches

Dimensions:

- Large base (GB) = 760 mm
- Beam height (HSP) = 450 mm
- Small base (PB) = 200 mm
- Teeth can be welded on request



PART NUMBER	WEIGHT (kg)*	PRICE EXCL. VAT (€)
TMP001-M1	71	-

## Suspension link

Tool for single-axis articulation of products already fitted with a suspension system

Diameter 40 mm x Width 90 mm



PART NUMBER	WEIGHT (kg)*	PRICE EXCL. VAT (€)
5001834	26	-

## Universal joint

Tool for articulating, along two axes, a gripper, a grapple, an auger, etc.

PART NUMBER	WEIGHT (kg)*	PRICE EXCL. VAT (€)
UNIVERSAL JOINT-M1	Depending on equipment	-



## Ripper tooth

Ripper tooth for work on rocky terrain

R = 758 60 mm 1 tooth ESCO U20P



PART NUMBER	WEIGHT (kg)*	PRICE EXCL. VAT (€)
5063285	50	-

## Pin-on adapter

Tool for pinning your hydraulic equipment using two pins



PART NUMBER	WEIGHT (kg)*	PRICE EXCL. VAT (€)
BERCEAU-M1	Depending on size	-

## Bolt-on adapter

Tool for bolting on hydraulic equipment



PART NUMBER	WEIGHT (kg)*	PRICE EXCL. VAT (€)
BOLT-ON ADAPTER-M1	Depending on equipment	-

ITEM CODE	BRANDS
5002007	BOBCAT: HB580   HB380   B300   DOOSAN: DA120 MONTABERT: 95/95HD   85/85HD   30/50/70   SC8   SC12 NEUSON: NE8   NE12
5035996	EPIROC: SB152   SB150-MK2   MG200   MG 300   CC350   JCB: HM166Q   HM012T   KUBOTA: KM155

# SPECIAL TOOLS

Morin Original system coupler MI for machines from 2t to 3.5t  
Couplers available on pages 18 to 30

Non-exhaustive list. Please contact us for more information.

Some situations require special dimensions or configurations. That's why ACB+ is at your disposal for any specific requests. Our SPECIAL TOOLS are made to measure. So you have a choice of teeth, pitch, width, etc. Here are just a few examples.

(\*) Weight variation of +/- 2% depending on equipment

## Grid backhoe

Tool for sieving rubble and pebbles.  
Grid backhoe Range 12 - 600 mm  
4 teeth ESCO V13SYL - Pitch 70 mm



PART NUMBER	WEIGHT (kg)*	PRICE EXCL. VAT (€)
5058569	82	-

## Cemetery bucket

Wide-opening bucket to optimise vertical digging close to the machine  
Cemetery Bucket Range 12 - 400 mm - 0.047m3  
3 teeth MTG MG5L



PART NUMBER	WEIGHT (kg)*	PRICE EXCL. VAT (€)
5075373	64	-

## Grid ditch cleaning bucket

Tool for small jobs sorting materials on the ground over a broad strip.  
Grid ditch cleaning bucket 1,000 mm  
Pitch 70 x 140 mm - Bladeless profile



PART NUMBER	WEIGHT (kg)*	PRICE EXCL. VAT (€)
5090226	88	-

Tool for sorting loose materials containing pebbles  
Grid ditch cleaning bucket 1,200 mm  
Pitch 120 x 100 mm - 8 Teeth MTG MG5V  
Scalloped blade



PART NUMBER	WEIGHT (kg)*	PRICE EXCL. VAT (€)
5081389	113	-

# SPECIAL TOOLS

Morin Original system coupler MI  
for machines from 2t to 3.5t  
Couplers available on pages 18 to 30

## Universal grading bucket

Finishing tool for rotating couplers and tiltrotators  
Universal grading bucket 1000 mm  
0.102m<sup>3</sup> - Profile 1UP1



PART NUMBER	WEIGHT (kg)*	PRICE EXCL. VAT (€)
5154231	93	-

## Rake

A tool for small-scale landscape finishing work, such as grading and sorting materials on the ground, etc. 1200 mm rake - Pitch 60 mm



PART NUMBER	WEIGHT (kg)*	PRICE EXCL. VAT (€)
5076229	83	-

## Stump grinder tooth

Tool for levelling (cutting) stumps and completing stump removal  
Stump grinder -  
R = 593 mm - 50 mm



PART NUMBER	WEIGHT (kg)*	PRICE EXCL. VAT (€)
5159116	46	-

## Front and rear rake

Tool for small forestry jobs to create swaths by pulling and pushing  
Front and Rear Rake  
1,000 mm 9 Claws - Pitch 100 mm



PART NUMBER	WEIGHT (kg)*	PRICE EXCL. VAT (€)
5089072	151	-

## Claw backhoe

Tool for gripping and manipulating objects -  
Claw backhoe 700 mm  
0.128m<sup>3</sup> - 5 Teeth ESCO  
V13SYL



PART NUMBER	WEIGHT (kg)*	PRICE EXCL. VAT (€)
5079514	162	-

(\*) Weight variation of +/- 2% depending on equipment



# BUCKET SETS - EXPRESS OPTION

DELIVERED WITHIN 5 WORKING DAYS

Morin Original system coupler MI | for machines from 2t to 3.5t | Couplers available on pages 18 to 30

To save time and increase convenience, ACB+ stocks palletised bucket sets. These consist of two earthmoving buckets and one ditch cleaning bucket selected from the most popular sizes.

(\*) Weight variation of +/- 2% depending on equipment

(\*\*) Depending on availability | Stock item ■

## Narrow bucket set range I2



## Narrow bucket set range I2



ITEM CODE	CONTAINER	DESIGNATION	TEETH	WEIGHT (kg)*	PRICE EXCL. VAT (€)	BUCKET SET + COUPLER MIS**
5070757	5020729	1 backhoe Range 12 - Width 300 mm	ESCO V13SYL	207	-	-
	5020739	1 backhoe Range 12 - Width 500 mm				
	5001384	1 ditch cleaning bucket Profile P1 - Width 1,000 mm				

## Wide bucket set range I2



## Wide bucket set range I2



ITEM CODE	CONTAINER	DESIGNATION	TEETH	WEIGHT (kg)*	PRICE EXCL. VAT (€)	BUCKET SET + COUPLER MIS**
5082289	5020729	1 backhoe Range 12 - Width 300 mm	ESCO V13SYL	216	-	-
	5020739	1 backhoe Range 12 - Width 500 mm				
	5001386	1 ditch cleaning bucket Profile P1 - Width 1,200 mm				

# BUCKET SETS - EXPRESS OPTION

DELIVERED WITHIN 5 WORKING DAYS

Morin Original system coupler M1 | for machines from 2t to 3.5t | Couplers available on pages 18 to 30

To save time and increase convenience, ACB+ stocks palletised bucket sets. These consist of two earthmoving buckets and one ditch cleaning bucket selected from the most popular sizes.

(\*) Weight variation of +/- 2% depending on equipment

(\*\*) Depending on availability | Stock item ■

Bucket set range I3



Bucket set range I3



ITEM CODE	CONTAINER	DESIGNATION	TEETH	WEIGHT (kg)*	PRICE EXCL. VAT (€)	BUCKET SET + COUPLER M1S**
5073716	5021997	1 backhoe Range 13 - Width 300 mm	ESCO V13SYL	226	-	-
	5021998	1 backhoe Range 13 - Width 500 mm				
	5001386	1 ditch cleaning bucket Profile P1 - Width 1,200 mm				