

# MODULE 2



Classic mechanical couplers 55 kg



Classic hydraulic couplers 61 kg

**Morin Original system coupler M2**  
for machines from 3.5t to 5.5t  
Couplers available on pages 18 to 30

## Morin Original system tool summary - Module 2

<b>Backhoes</b>	<b>86</b>
Range 22	86
Range 23	90
<b>Banana buckets</b>	<b>94</b>
<b>Fixed ditch cleaning buckets</b>	<b>96</b>
<b>Tilt ditch cleaning buckets</b>	<b>97</b>
<b>Standard tools</b>	<b>98</b>
<b>Special tools</b>	<b>100</b>
<b>Bucket sets</b>	<b>102</b>

Hydraulic kit for powering and controlling hydraulic coupler 5163582. **More information on page 43.**

## Machines assigned to this module

BRAND	MACHINES	BUCKET RANGE	TINE CLASS
ACB+	REVERSIBLE KIT M2	-	-
AMMANN	AMX42   AMX45	22	D5
	AMX 50ZT   AMX 55	23	D5
	AMX58   AMX60   AMX60ZT   AMX65	23	D8
BOBCAT	E45   E50   E50Z   E55   E55Z   E60	22	D8
	E57W   E62	23	D8
CASE	CX42D   CX45D	22	D5
	CX50D   CX55D   CX57C   CX58D   CX60C/D   CX65D	23	D8
CATERPILLAR	304C-CR   305C-CR   305CRNG   305D-CR   305.5D-CR   305.5E-CR   305E2   306   306.5   306.6CR   304.5   304CR   305CR	23	D8
	COLTRAX	CX50   CX57   CX58   CX60   CX62ST	23
DEVELON	DX55R-7   DX57W-7   DX62R-3/7   DX63-3/7	23	D8
EUROCOMACH	42ZT   45TR	22	D5
	50ZT   55TR	23	D5
	57ZT   60ZT   65TR	23	D8
EUROMACH	R45 BIGFOOT FORESTER	22	D5
HANIX	H55DR	23	D8
HITACHI	ZX48U-6   ZX55U-6   ZX55U-6EB	22	D5
HYUNDAI	R55-9A   R55W-9A   R60CR-9   HW65A   HX65A	22	D8
	HX48AZ	23	D5
JCB	50Z-2   56Z-2	22	D8
KATO IMER IHI	HD50V5   HD60V5	23	D5
KOBELCO	SK50SRX-7   SK58SRX-7	22	D8
KOMATSU	PC58MR-5	23	D5

BRAND	MACHINES	BUCKET RANGE	TINE CLASS
KUBOTA	KX042-4a	22	D5
	KX057-4   U55-4	23	D8
	U50-5   U56-5   KX060-5	23	D5
NEW-HOLLAND	E450D   E55D   E60D   E65D	23	D5
SANY	SY50U	23	D5
SUNWARD	SWE40U   SWE50B	22	D5
	SWE60UF	23	D8
TAKEUCHI	TB250-2   TB257FR   TB350R 6 TB260	22	D8
TEREX	TC35   TC37	22	D5
	TC48   TC50	23	D5
	TC60	23	D8
VOLVO	EC40   EC45	22	D5
	ECR50   ECR50F   ECR58   ECR58F   EC60E   EW60E   FROM 2021	22	D8
WACKER-NEUSON	ET/EW65   EZ53	22	D8
	ET42	22	D5
	ET58   EZ50	23	D5
XCMG	XE55E	23	D8
YANMAR	Vio50-6B   Vio57-6B   SV60-6B	<b>23</b>	<b>D8</b>

# BACKHOE RANGE 22

Morin Original system coupler M2  
for machines from 3.5t to 5.5t  
Couplers available on pages 18 to 30

Specially designed for construction and renovation work, BACKHOE BUCKETS will satisfy your needs, whether you are working in a loose environment or a much more challenging one. They can be reinforced to withstand extreme conditions. So please don't hesitate to ask.

## Profile PIN



## Toothless bucket

PART NUMBER	WIDTH (mm)	ISO CAPACITY (l)	BUCKET WEIGHT (kg)*	TOTAL WEIGHT (kg)	PRICE EXCL. VAT (€)	ITEM CODE
R22-300	300	58	64	168	-	5020575
R22-350	350	69	69	193	-	5019232
R22-400	400	82	77	225	-	5016821
R22-450	450	95	83	254	-	5019493
R22-500	500	108	88	282	-	5016818
R22-550	550	125	95	320	-	5101041
R22-600	600	136	100	345	-	5034238
R22-650	650	153	110	385	-	5101042
R22-700	700	166	111	410	-	5059620
R22-750	750	180	116	440	-	5071844
R22-800	800	184	132	463	-	5016820
R22-850	850	201	151	513	-	5101043
R22-900	900	210	144	522	-	5016819

(\* Weight variation of +/- 2 % depending on equipment | Total weight = (ISO capacity in l x Density 1.8) + Bucket weight in kg

# BACKHOE RANGE 22

Morin Original system coupler M2  
for machines from 3.5t to 5.5t  
Couplers available on pages 18 to 30

Thickness = Blade thickness | (\*) Weight variation +/- 2% depending on equipment | Total weight = (ISO capacity in l x Density 1.8) + Bucket weight in kg | Average number of teeth | Stock item ■

## Profile PIN

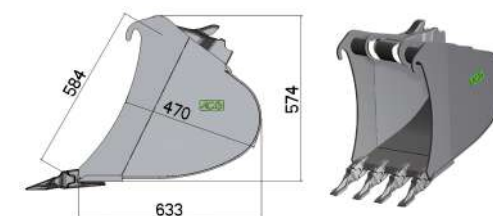

## Bucket with RBCB or teeth

### REVERSIBLE BOLT-ON COUNTER-BLADE

Thickness 20 mm



### CAT 1U3202

Thickness 20 mm



### COMBI MINI T29

Thickness 20 mm



### ESCO V17TYL

Thickness 20 mm



PART NUMBER	WIDTH (mm)	ISO CAPACITY (l)	BUCKET WEIGHT (kg)*	TOTAL WEIGHT (kg)	PRICE EXCL. VAT (€)	NUMBER OF TEETH	ITEM CODE	NUMBER OF TEETH	ITEM CODE	NUMBER OF TEETH	ITEM CODE	NUMBER OF TEETH	ITEM CODE
R22-300	300	58	72	176	-	RBCB	5016874	3	5016865	3	5038575	3	5014226
R22-350	350	69	77	201	-	RBCB	5100976	3	5066706	3	5045008	3	5015063
R22-400	400	82	85	233	-	RBCB	5016873	3	5016855	3	5040304	3	5015035
R22-450	450	95	91	262	-	RBCB	5039292	3	5016854	3	5037670	3	5015017
R22-500	500	108	99	293	-	RBCB	5016872	4	5059062	4	5040302	4	5015028
R22-550	550	125	105	330	-	RBCB	5100977	4	5059061	4	5100967	4	5015087
R22-600	600	136	110	355	-	RBCB	5016869	4	5016852	4	5037417	4	5014395
R22-650	650	153	116	391	-	RBCB	5100978	4	5071962	5	5100968	4	5015080
R22-700	700	166	124	423	-	RBCB	5100979	5	5016851	5	5037671	5	5015050
R22-750	750	180	130	454	-	RBCB	5100980	5	5036687	5	5042471	5	5015072
R22-800	800	184	148	479	-	RBCB	5100982	6	5016848	5	5040305	5	5015041
R22-850	850	201	154	516	-	RBCB	5100983	6	5101029	6	5100969	6	5039661
R22-900	900	210	160	538	-	RBCB	5100985	6	5101030	6	5040303	6	5016836

# BACKHOE RANGE 22

Morin Original system coupler M2  
for machines from 3.5t to 5.5t  
Couplers available on pages 18 to 30

Specially designed for construction and renovation work, BACKHOE BUCKETS will satisfy your needs, whether you are working in a loose environment or a much more challenging one. They can be reinforced to withstand extreme conditions. So please don't hesitate to ask.

Thickness = Blade thickness | (\*) Weight variation +/- 2% depending on equipment | Total weight = (ISO capacity in l x Density 1.8) + Bucket weight in kg | Average tooth count

## Profile PIN

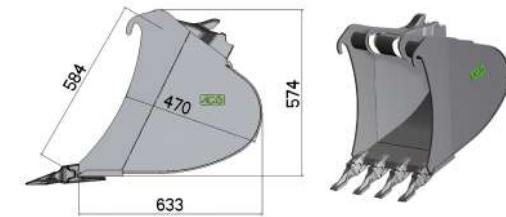

## Bucket with teeth

PART NUMBER	WIDTH (mm)	ISO CAPACITY (l)	BUCKET WEIGHT (kg)*	TOTAL WEIGHT (kg)	PRICE EXCL. VAT (€)	NUMBER OF TEETH	ITEM CODE	NUMBER OF TEETH	ITEM CODE	NUMBER OF TEETH	ITEM CODE
R22-300	300	58	71	175	-	3	5037343	3	5082524	3	5058500
R22-350	350	69	76	200	-	3	5039124	3	5100935	3	5023053
R22-400	400	82	84	232	-	3	5038191	3	5077127	3	5046308
R22-450	450	95	89	260	-	3	5037549	3	5082158	3	5040112
R22-500	500	108	97	291	-	4	5042979	4	5082525	4	5052985
R22-550	550	125	103	328	-	4	5087977	4	5100946	4	5053056
R22-600	600	136	109	354	-	4	5037479	4	5100948	4	5101012
R22-650	650	153	115	390	-	4	5050819	4	5100949	4	5101013
R22-700	700	166	123	422	-	5	5039125	5	5094077	5	5052986
R22-750	750	180	129	453	-	5	5037344	5	5094385	5	5048451
R22-800	800	184	144	475	-	5	5037480	5	5082159	5	5046309
R22-850	850	201	151	513	-	6	5044858	5	5100950	6	5101016
R22-900	900	210	158	536	-	6	5040072	6	5100951	6	5040113

**FEURST FKITLR**  
Thickness 20 mm



**FUTURA FT170S**  
Thickness 20 mm



**JCB 531-03205D**  
Thickness 20 mm



# BACKHOE RANGE 22

Morin Original system coupler M2  
for machines from 3.5t to 5.5t  
Couplers available on pages 18 to 30

(\*) Weight variation of +/- 2% depending on equipment | Total weight = (ISO capacity in l x Density 1.8) + Bucket weight in kg | Average number of teeth

## Profile PIN

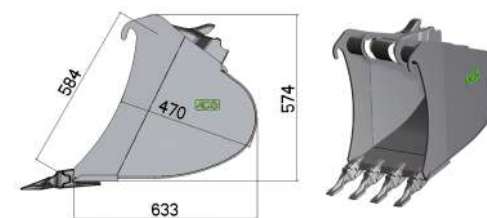

## Bucket with teeth

PART NUMBER	WIDTH (mm)	ISO CAPACITY (l)	BUCKET WEIGHT (kg)*	TOTAL WEIGHT (kg)	PRICE EXCL. VAT (€)	NUMBER OF TEETH	ITEM CODE	NUMBER OF TEETH	ITEM CODE
R22-300	300	58	71	175	-	3	5016723	3	5083772
R22-350	350	69	76	200	-	3	5016800	3	5087100
R22-400	400	82	84	232	-	3	5016817	3	5086114
R22-450	450	95	89	260	-	3	5016810	3	5100867
R22-500	500	108	98	292	-	4	5016816	4	5100868
R22-550	550	125	103	328	-	4	5016807	4	5100870
R22-600	600	136	108	353	-	4	5016806	4	5071736
R22-650	650	153	114	389	-	4	5027767	4	5100871
R22-700	700	166	123	422	-	5	5016803	5	5100875
R22-750	750	180	127	451	-	5	5016801	5	5087101
R22-800	800	184	143	474	-	5	5016735	5	5100875
R22-850	850	201	152	514	-	6	5041231	5	5100888
R22-900	900	210	158	536	-	6	5027768	5	5086117

### MTG MG8L

Thickness 20 mm



### VOLVO 8GPC

Thickness 20 mm



# BACKHOE RANGE 23

Morin Original system coupler M2  
for machines from 3.5t to 5.5t  
Couplers available on pages 18 to 30

Specially designed for construction and renovation work, BACKHOE BUCKETS will satisfy your needs, whether you are working in a loose environment or a much more challenging one. They can be reinforced to withstand extreme conditions. So please don't hesitate to ask.

## Profile PIN



## Toothless bucket

PART NUMBER	WIDTH (mm)	ISO CAPACITY (l)	BUCKET WEIGHT (kg)*	TOTAL WEIGHT (kg)	PRICE EXCL. VAT (€)	ITEM CODE
R23-300	300	68	67	189	-	5016549
R23-350	350	84	72	223	-	5044945
R23-400	400	100	80	260	-	5017618
R23-450	450	116	85	294	-	5040565
R23-500	500	126	92	319	-	5016550
R23-550	550	148	98	364	-	5101045
R23-600	600	164	103	398	-	5016533
R23-650	650	181	108	434	-	5078067
R23-700	700	197	115	470	-	5063884
R23-750	750	214	121	506	-	5044946
R23-800	800	218	134	526	-	5056479
R23-850	850	233	141	560	-	5024290
R23-900	900	264	147	622	-	5036092
R23-1000	1000	297	159	694	-	5044947

(\* Weight variation of +/- 2 % depending on equipment | Total weight = (ISO capacity in l x Density 1.8) + Bucket weight in kg

# BACKHOE RANGE 23

Morin Original system coupler M2  
for machines from 3.5t to 5.5t  
Couplers available on pages 18 to 30

Thickness = Blade thickness | (\*) Weight variation +/- 2%  
depending on equipment | Total weight = (ISO capacity in l x  
Density 1.8) + Bucket weight in kg | Average tooth count

## Profile PIN

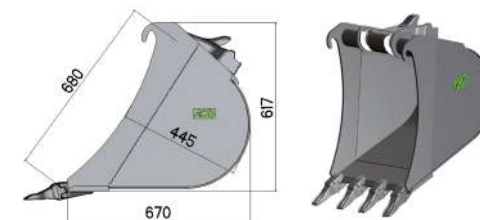

## Bucket with RBCB or teeth

### REVERSIBLE BOLT-ON COUNTER-BLADE Thickness 20 mm



### CAT 1U3202 Thickness 20 mm



### CAT2 6Y6335 Thickness 20 mm



### COMBI MINI T29 Thickness 20 mm



PART NUMBER	WIDTH (mm)	ISO CAPACITY (l)	BUCKET WEIGHT (kg)*	TOTAL WEIGHT (kg)	PRICE EXCL. VAT (€)	NUMBER OF TEETH	ITEM CODE	NUMBER OF TEETH	ITEM CODE	NUMBER OF TEETH	ITEM CODE	NUMBER OF TEETH	ITEM CODE
R23-300	300	68	74	196	-	RBCB	5028506	3	5069342	3	5032464	3	5042343
R23-350	350	84	80	231	-	RBCB	5027139	3	5058383	3	5045643	3	5040631
R23-400	400	100	88	268	-	RBCB	5024746	3	5054225	3	5038824	3	5042884
R23-450	450	116	93	302	-	RBCB	5056858	3	5069290	3	5033090	3	5044494
R23-500	500	126	102	329	-	RBCB	5041406	4	5016547	4	5035117	4	5040271
R23-550	550	148	108	374	-	RBCB	5100986	4	5101031	4	5057241	5	5100970
R23-600	600	164	113	408	-	RBCB	5100987	4	5089186	4	5041078	4	5042344
R23-650	650	181	120	446	-	RBCB	5100988	4	5101032	4	5045814	5	5100971
R23-700	700	197	128	483	-	RBCB	5100989	5	5068058	5	5036009	5	5042345
R23-750	750	214	134	519	-	RBCB	5100990	5	5054226	5	5035118	5	5050450
R23-800	800	218	150	542	-	RBCB	5100991	6	5058384	5	5042850	5	5040632
R23-850	850	233	157	576	-	RBCB	5100992	6	5101033	5	5101056	6	5100972
R23-900	900	264	163	638	-	RBCB	5092415	6	5071074	6	5033091	6	5040272
R23-1000	1000	297	178	713	-	RBCB	5100993	7	5101034	6	5101057	6	5045468

# BACKHOE RANGE 23

Morin Original system coupler M2  
for machines from 3.5t to 5.5t  
Couplers available on pages 18 to 30

Specially designed for construction and renovation work, BACKHOE BUCKETS will satisfy your needs, whether you are working in a loose environment or a much more challenging one. They can be reinforced to withstand extreme conditions. So please don't hesitate to ask.

Thickness = Blade thickness | (\*) Weight variation +/- 2% depending on equipment | Total weight = (ISO capacity in l x Density 1.8) + Bucket weight in kg | Average number of teeth | Stock item ■

## Profile PIN

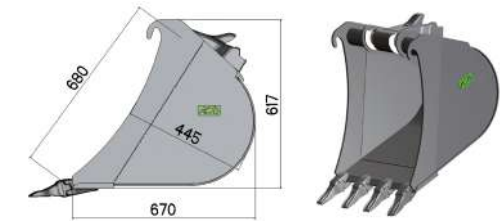

ESCO V17TYL  
Thickness 20 mm



FEURST FK1TLR  
Thickness 20 mm



FUTURA FT170S  
Thickness 20 mm



## Bucket with teeth

PART NUMBER	WIDTH (mm)	ISO CAPACITY (l)	BUCKET WEIGHT (kg)*	TOTAL WEIGHT (kg)	PRICE EXCL. VAT (€)	NUMBER OF TEETH	ITEM CODE	NUMBER OF TEETH	ITEM CODE	NUMBER OF TEETH	ITEM CODE
R23-300	300	68	75	197	-	3	5007246	3	5040258	3	5080874
R23-350	350	84	80	231	-	3	5013317	3	5039728	3	5084903
R23-400	400	100	88	268	-	3	5015928	3	5039624	3	5086907
R23-450	450	116	94	303	-	3	5010771	3	5040223	3	5086771
R23-500	500	126	102	329	-	4	5015935	4	5032463	4	5078639
R23-550	550	148	108	374	-	4	5016208	4	5053626	4	5100952
R23-600	600	164	114	409	-	4	5007245	4	5039729	4	5078640
R23-650	650	181	108	434	-	4	5016200	4	5049504	4	5100953
R23-700	700	197	128	483	-	5	5015937	5	5046447	5	5085850
R23-750	750	214	134	519	-	5	5015943	5	5057295	5	5093105
R23-800	800	218	148	540	-	5	5015948	5	5039623	5	5082049
R23-850	850	233	157	576	-	6	5024477	6	5090529	5	5100954
R23-900	900	264	163	638	-	6	5016229	6	5037921	6	5086905
R23-1000	1000	297	190	725	-	7	5007247	7	5032465	6	5078641



# BACKHOE RANGE 23

Morin Original system coupler M2  
for machines from 3.5t to 5.5t  
Couplers available on pages 18 to 30

(\*) Weight variation of +/- 2% depending on equipment | Total weight = (ISO capacity in l x Density 1.8) + Bucket weight in kg | Average number of teeth

## Profile PIN

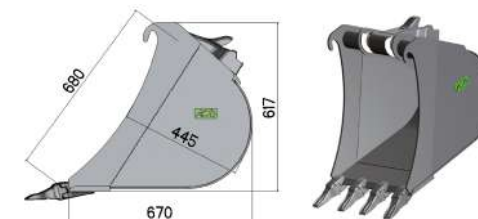

## Bucket with teeth

PART NUMBER	WIDTH (mm)	ISO CAPACITY (l)	BUCKET WEIGHT (kg)*	TOTAL WEIGHT (kg)	PRICE EXCL. VAT (€)	JCB 531-03205D		MTG MG8L		VOLVO 8GPC	
						NUMBER OF TEETH	ITEM CODE	NUMBER OF TEETH	ITEM CODE	NUMBER OF TEETH	ITEM CODE
R23-300	300	68	77	199	-	3	5015961	3	5016510	3	5100894
R23-350	350	84	82	233	-	3	5016275	3	5016512	3	5100895
R23-400	400	100	91	271	-	3	5015951	3	5016500	3	5090656
R23-450	450	116	95	304	-	3	5016278	3	5016509	3	5100896
R23-500	500	126	105	332	-	4	5015964	4	5020616	3	5100899
R23-550	550	148	111	377	-	4	5101018	4	5059330	4	5100901
R23-600	600	164	117	412	-	4	5015958	4	5016492	4	5090657
R23-650	650	181	122	448	-	4	5016448	4	5020652	4	5100902
R23-700	700	197	132	487	-	5	5016446	5	5019980	4	5100903
R23-750	750	214	137	522	-	5	5101019	5	5016511	5	5100904
R23-800	800	218	152	544	-	5	5007369	5	5016451	5	5100905
R23-850	850	233	157	576	-	6	5101020	6	5064620	5	5100906
R23-900	900	264	168	643	-	6	5016280	6	5025814	6	5090659
R23-1000	1000	297	180	715	-	7	5020237	7	5044045	6	5100907

JCB 531-03205D  
Thickness 20 mm



MTG MG8L  
Thickness 20 mm



VOLVO 8GPC  
Thickness 20 mm



# BANANA BUCKETS

Morin Original system coupler M2  
for machines from 3.5t to 5.5t  
Couplers available on pages 18 to 30

Thanks to its narrow width, the BANANA BUCKET is ideal for work requiring precision, such as small trenches or cable installation.

Thickness = Blade thickness | (\*) Weight variation +/- 2% depending on equipment | Total weight = (ISO capacity in l x Density 1.8) + Bucket weight in kg | Average tooth count

## Profile 2



## Profile 2

					TOOTHLESS Thickness 20 mm		REVERSIBLE BOLT-ON COUNTER-BLADE Thickness 20 mm			ESCO V17TYL Thickness 20 mm			FEURST FKITLR Thickness 20 mm		
PART NUMBER	WIDTH (mm)	ISO CAPACITY (l)	BUCKET WEIGHT (kg)*	TOTAL WEIGHT (kg)	PRICE EXCL. VAT (€)	ITEM CODE	PRICE EXCL. VAT (€)	NUMBER OF TEETH	ITEM CODE	PRICE EXCL. VAT (€)	NUMBER OF TEETH	ITEM CODE	PRICE EXCL. VAT (€)	NUMBER OF TEETH	ITEM CODE
2GL-2-260	260	29	55	107	-	5003833	-	2	5057083	-	2	5035202	-	2	5039350
2GL-2-300	300	34	60	121	-	5003934	-	2	5119193	-	2	5121354	-	2	5133811

## Profile 3



## Profile 3

					TOOTHLESS Thickness 15 mm		COMBI MINI T29 Thickness 20 mm			FEURST FKITLR Thickness 20 mm			MTG MG5L Thickness 20 mm		
PART NUMBER	WIDTH (mm)	ISO CAPACITY (l)	BUCKET WEIGHT (kg)*	TOTAL WEIGHT (kg)	PRICE EXCL. VAT (€)	ITEM CODE	PRICE EXCL. VAT (€)	NUMBER OF TEETH	ITEM CODE	PRICE EXCL. VAT (€)	NUMBER OF TEETH	ITEM CODE	PRICE EXCL. VAT (€)	NUMBER OF TEETH	ITEM CODE
2GL-3-200	200	28	74	124	-	5002795	-	2	T29	-	2	5063731	-	2	5058904
2GL-3-250	250	33	80	139	-	5007326	-	2	5072473	-	2	FKITLR	-	2	MG5L

# BANANA BUCKETS

Morin Original system coupler M2  
for machines from 3.5t to 5.5t  
Couplers available on pages 18 to 30

**Profile 3**

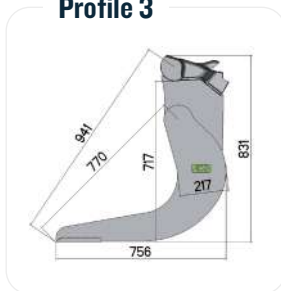

Thickness = Blade thickness | (\*) Weight variation +/- 2% depending on equipment | Total weight = (ISO capacity in l x Density 1.8) + Bucket weight in kg | Average number of teeth | Stock item

**Profile 5**



**TOOTHLESS**

Thickness 20 mm



## Profile 3

PART NUMBER	WIDTH (mm)	ISO CAPACITY (l)	BUCKET WEIGHT (kg)*	TOTAL WEIGHT (kg)	PRICE EXCL. VAT (€)	NUMBER OF TEETH	ITEM CODE
2GL-3-200	200	28	80	130	-	2	5055707
2GL-3-250	250	33	85	144	-	2	V17TYL

**ESCO V17TYL**

Thickness 20 mm



## Profile 5

PART NUMBER	WIDTH (mm)	ISO CAPACITY (l)	BUCKET WEIGHT (kg)*	TOTAL WEIGHT (kg)	PRICE EXCL. VAT (€)	ITEM CODE
2GL-5-200	200	51	91	183	-	5017289
2GL-5-250	250	68	94	216	-	5034674

## Profile 4

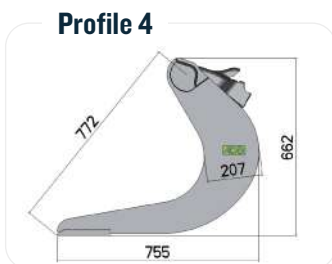

**TOOTHLESS**

Thickness 20 mm



**REVERSIBLE BOLT-ON COUNTER-BLADE**

Thickness 20 mm



**ESCO V17TYL**

Thickness 25 mm



**MTG MG8L**

Thickness 25 mm



PART NUMBER	WIDTH (mm)	ISO CAPACITY (l)	BUCKET WEIGHT (kg)*	TOTAL WEIGHT (kg)	PRICE EXCL. VAT (€)	ITEM CODE	PRICE EXCL. VAT (€)	ITEM CODE	PRICE EXCL. VAT (€)	NUMBER OF TEETH	ITEM CODE	PRICE EXCL. VAT (€)	NUMBER OF TEETH	ITEM CODE
2GL-4-260	260	46	66	149	-	5001849	-	5015505	-	3	V17TYL	-	2	5087178
2GL-4-300	300	51	71	163	-	5001850	-	5060185	-	3	5076982	-	3	MG8L

# FIXED DITCH CLEANING BUCKETS

Morin Original system coupler M2  
for machines from 3.5t to 5.5t  
Couplers available on pages 18 to 30

The DITCH CLEANING BUCKET can be used for finishing work such as ditch cleaning, embanking, levelling and much more.

Thickness = Blade thickness | (\*) Weight variation +/- 2% depending on equipment | Total weight = (ISO capacity in l x Density 1.8) + Bucket weight in kg | Stock item ■

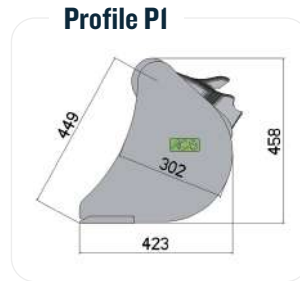

## Profile P1

PART NUMBER	WIDTH (mm)	ISO CAPACITY (l)	BUCKET WEIGHT (kg)*	TOTAL WEIGHT (kg)	PRICE EXCL. VAT (€)	ITEM CODE	BUCKET WEIGHT (kg)*	TOTAL WEIGHT (kg)	PRICE EXCL. VAT (€)	ITEM CODE
CM2-1000-P1	1,000	140	100	352	-	5001391	131	383	-	5088949
CM2-1200-P1	1,200	171	114	422	-	5001392	150	458	-	5010230
CM2-1300-P1	1,300	186	121	456	-	5001393	159	494	-	5072177
CM2-1400-P1	1,400	200	128	488	-	5001394	169	529	-	5013047
CM2-1500-P1	1,500	216	135	524	-	5001395	179	568	-	5020394
CM2-1600-P1	1,600	230	141	555	-	5001396	188	602	-	5053523



## Profile P3

PART NUMBER	WIDTH (mm)	ISO CAPACITY (l)	BUCKET WEIGHT (kg)*	TOTAL WEIGHT (kg)	PRICE EXCL. VAT (€)	ITEM CODE	BUCKET WEIGHT (kg)*	TOTAL WEIGHT (kg)	PRICE EXCL. VAT (€)	ITEM CODE
CM2-1000-P3	1,000	167	108	409	-	5004934	138	439	-	RBCB
CM2-1200-P3	1,200	202	123	487	-	5003578	157	521	-	5025336
CM2-1300-P3	1,300	220	130	526	-	5006283	139	535	-	5138992
CM2-1400-P3	1,400	238	138	566	-	5001852	178	606	-	5013467
CM2-1500-P3	1,500	255	145	604	-	5003994	188	647	-	5020650
CM2-1600-P3	1,600	270	152	638	-	5017169	200	686	-	5127121

# TILT DITCH CLEANING BUCKETS

Morin Original system coupler M2  
for machines from 3.5t to 5.5t  
Couplers available on pages 18 to 30

The TILT DITCH CLEANING BUCKET can be used for finishing work such as ditch cleaning, embanking, levelling and much more. The tilting version is stable on the ground and remains upright to facilitate the next attachment.

Thickness = Blade thickness | (\*) Weight variation +/- 2% depending on equipment | Total weight = (ISO capacity in l x Density 1.8) + Bucket weight in kg  
Stock item ■

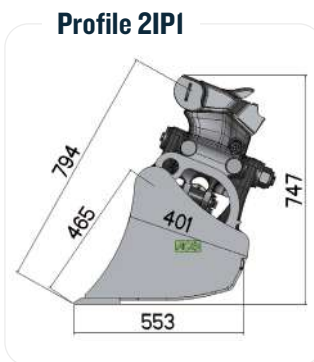

## Profile 2IPI 2 x 45° - 1 Cylinder



PART NUMBER	WIDTH (mm)	ISO CAPACITY (l)	BUCKET WEIGHT (kg)*	TOTAL WEIGHT (kg)	PRICE EXCL. VAT (€)	ITEM CODE	BUCKET WEIGHT (kg)*	TOTAL WEIGHT (kg)	PRICE EXCL. VAT (€)	ITEM CODE
2IPI-1400	1,400	233	245	664	-	5070045	286	705	-	5074289

## Retaining kit

Optional retaining kits are available to compensate for hydraulic leaks and keep the tilt ditch cleaning bucket in the desired position.

MODULE	ITEM CODE	PRICE EXCL. VAT (€)
M2	5078655	-

# STANDARD TOOLS

Morin Original system coupler M2  
for machines from 3.5t to 5.5t  
Couplers available on pages 18 to 30

As a bucket isn't always enough, a range of TOOLS is available to meet all your needs. For more information, please refer to the attached product specification sheets or contact us.

(\*) Weight variation of +/- 2% depending on equipment  
Stock item ■

## Trapezoidal bucket with 65° angles

Bucket for creating profiled ditches  
Dimensions:

- Large base (GB) = 1,000 mm
- Beam height (HSP) = 600 mm
- Small base (PB) = 300 mm
- Teeth can be welded on request



PART NUMBER	WEIGHT (kg)*	PRICE EXCL. VAT (€)
TTP001-M2	141	-

## Suspension link

Tool for single-axis articulation  
of products already fitted with  
a suspension system

Diameter 40 mm x Width 90 mm



PART NUMBER	WEIGHT (kg)*	PRICE EXCL. VAT (€)
5007249	35	-

## Universal joint

Tool for articulating, along two axes,  
a gripper, a grapple, an auger, etc.

PART NUMBER	WEIGHT (kg)*	PRICE EXCL. VAT (€)
UNIVERSAL JOINT-M2	Depending on equipment	-



## Ripper tooth

Ripper tooth for work on rocky  
terrain

R = 900 60 mm 1 tooth ESCO U20P



PART NUMBER	WEIGHT (kg)*	PRICE EXCL. VAT (€)
5063288	80	-

## Pin-on adapter

Tool for pinning your hydraulic  
equipment using two pins



PART NUMBER	WEIGHT (kg)*	PRICE EXCL. VAT (€)
BERCEAU-M2	Depending on size	-

## Bolt-on adapter

Tool for bolting on hydraulic  
equipment



PART NUMBER	WEIGHT (kg)*	PRICE EXCL. VAT (€)
BOLT-ON ADAPTER-M2	Depending on equipment	-

ITEM CODE	BRANDS
5003997	BOBCAT: HB980   HB880   B955S   B955   B950   B855S   B855   DOOSAN: DA280   DA220   MONTABERT: 95MS   85MS   SC28   SC22   NEUSON: NE28   NE22
5030027	EPIROC: SB202   SB200   RM200   HC450   HC350   JCB: HM266Q   HM2650   KUBOTA: KM205

# STANDARD TOOLS

Morin Original system coupler M2 for machines from 3.5t to 5.5t  
Couplers available on pages 18 to 30

As a bucket isn't always enough, a range of TOOLS is available to meet all your needs. For more information, please refer to the attached product specification sheets or contact us.

(\*) Weight variation of +/- 2% depending on equipment

## 4 x l bucket

Multi-purpose tool enabling various operations to be carried out with a single tool, such as: loading, snow removal, levelling, etc.

Dimensions:

- Width 1350 mm,
- 245 l capacity

Teeth can be welded on request



PART NUMBER	WEIGHT (kg)*	PRICE EXCL. VAT (€)
4x1-M2-1350	232	-

## Pallet forks

There are two versions of our pallet forks:

- A simple version, for attachment using a quick coupler only.
- A version with an arrangement on the front blade, allowing the pallet forks to be attached to the blade, for use on sites only.

Depending on the profile of the excavator blade, we are obliged to:

- Place the pallet forks on the blade using simple hooks: the pallet forks can then be shifted sideways depending on site requirements.
- Fix the pallet forks to the blade with an arrangement to be welded onto the blade: the pallet forks remain in a fixed position.

To order your pallet forks, please specify which version you require. For the second version, the decision to weld or place depends on the blade profile of your machine. 800 kg forks



PART NUMBER	WEIGHT (kg)*	PRICE EXCL. VAT (€)
LP-M2-SIMPLE	140	-
LP-M2-SUR LAME	180	-



# SPECIAL TOOLS

Morin Original system coupler M2  
for machines from 3.5t to 5.5t  
Couplers available on pages 18 to 30

Non-exhaustive list. Please contact us for more information.

Some situations require special dimensions or configurations. That's why ACB+ is at your disposal for any specific requests. Our SPECIAL TOOLS are made to measure. So you have a choice of teeth, pitch, width, etc. Here are just a few examples.

(\*) Weight variation of +/- 2% depending on equipment

## Grid backhoe

Tool for sieving rubble and pebbles.  
Grid backhoe Range 23 - 900 mm  
6 teeth ESCO V17TYL - Pitch 70 mm



PART NUMBER	WEIGHT (kg)*	PRICE EXCL. VAT (€)
5072265	181	-

## Universal grading bucket

Finishing tool for rotating couplers and tiltrotators  
Universal grading bucket 1200 mm  
0.21m<sup>3</sup> - Profile 2UP1



PART NUMBER	WEIGHT (kg)*	PRICE EXCL. VAT (€)
5148087	154	-

## Grid ditch cleaning bucket

Tool for small jobs sorting materials on the ground over a broad strip.  
Grid ditch cleaning bucket 1,400 mm  
Pitch 60 x 60 mm - Bladeless profile with sidewall



PART NUMBER	WEIGHT (kg)*	PRICE EXCL. VAT (€)
5068541	132	-

Tool for sorting loose materials containing pebbles  
Grid ditch cleaning bucket 1,400 mm  
Pitch 131 x 100 mm - 8 Teeth MTG MG8V



PART NUMBER	WEIGHT (kg)*	PRICE EXCL. VAT (€)
5090743	156	-



# SPECIAL TOOLS

Morin Original system coupler M2 for machines from 3.5t to 5.5t  
Couplers available on pages 18 to 30

(\*) Weight variation of +/- 2% depending on equipment

## Rake

A tool for small-scale landscape finishing work, such as grading and sorting materials on the ground, etc. 1400 mm rake - Pitch 114 mm



PART NUMBER	WEIGHT (kg)*	PRICE EXCL. VAT (€)
5070175	81	-

## Stump grinder tooth

Tool for levelling (cutting) stumps and completing stump removal  
Stump grinder -  
R = 728 mm - 50 mm



PART NUMBER	WEIGHT (kg)*	PRICE EXCL. VAT (€)
5115892	84	-

## Front and rear rake

Tool for small forestry jobs to create swaths by pulling and pushing Front and Rear Rake  
1,500 mm 9 Claws - Pitch 153 mm



PART NUMBER	WEIGHT (kg)*	PRICE EXCL. VAT (€)
5093326	229	-

## Claw backhoe

Tool for gripping and manipulating objects -  
Claw backhoe 800 mm  
0.184m<sup>3</sup> - 5 Teeth ESCO  
V17TYL



PART NUMBER	WEIGHT (kg)*	PRICE EXCL. VAT (€)
5091103	234	-

# BUCKET SETS - EXPRESS OPTION

DELIVERED WITHIN 5 WORKING DAYS

Morin Original system coupler M2 | for machines from 3.5t to 5.5t | Couplers available on pages 18 to 30

To save time and increase convenience, ACB+ stocks palletised bucket sets. These consist of two earthmoving buckets and one ditch cleaning bucket selected from the most popular sizes.

(\*) Weight variation of +/- 2% depending on equipment

(\*\*) Depending on availability | Stock item ■

## Narrow bucket set range 23



## Narrow bucket set range 23



ITEM CODE	CONTAINER	DESIGNATION	TEETH	WEIGHT (kg)*	PRICE EXCL. VAT (€)	BUCKET SET + COUPLER M2S**
5073720	5007246 5015935 5001394	1 backhoe Range 23 - Width 300 mm 1 backhoe Range 23 - Width 500 mm 1 ditch cleaning bucket Profile P1 - Width 1,400 mm	ESCO V17TYL	330	-	-

## Wide bucket set range 23



## Wide bucket set range 23



ITEM CODE	CONTAINER	DESIGNATION	TEETH	WEIGHT (kg)*	PRICE EXCL. VAT (€)	BUCKET SET + COUPLER M2S**
5073721	5015928 5007245 5001394	1 backhoe Range 23 - Width 400 mm 1 backhoe Range 23 - Width 600 mm 1 ditch cleaning bucket Profile P1 - Width 1,400 mm	ESCO V17TYL	355	-	-