

MODULE 6



Classic hydraulic couplers 327 kg

Morin Original system coupler M6
for machines from 15t to 24t
Couplers available on pages 18 to 30

Morin Original system tool summary - Module 6

HD backhoes **152**

Range 61 TB1	152
Range 61 TB2	154
Range 61 TB3	157
Range 62 TB1	159
Range 62 TB2	161
Range 63 TB1	163

Banana buckets **164**

Fixed ditch cleaning buckets **165**

Tilt ditch cleaning buckets **167**

Standard tools **169**

Special tools **170**

Trapezoidal buckets **172**

Hydraulic kit for powering and controlling hydraulic coupler 5105978. **More information on page 43.**

In-cab display kit option page 20.

Machines assigned to this module

BRAND	MACHINES	BUCKET RANGE	TINE CLASS
CASE	CX160B/C/D CX180/C/D	61	D20
	CX210C CX210D CX230D CX245D	62	D30
	CX240 CX250D	62	D40
CATERPILLAR	M318F	60	D30
	315B 315C 315D 316E 316F 317B 318E 318F M318NG	61	D30
	320GC FROM 2018 TIMB&B1	62	D30
	320F-L 323 (new generation) 323F-L 325 325F-L 340LRE 352LRE NG TIM "B" & "B1" 320 323 325 326	63	D30
DEVELON	DX210-7 DX210NLC-7 DX225LC-7 DX225LC-7X DX235LCR-7 DX190W-7 DX210W-7 DX255LC-5 DX255LC-7	62	D40
HIDROMEK	HMK220 LC3	62	D40
HITACHI	ZX170W-5A	61	D20
	ZX180W-7	61	D30
	ZX210-7 ZX210W-5A ZX225US/USR	62	D40
HYUNDAI	HX180AL	61	D20
	HW210A HX220AL HX235CLR	62	D40
JCB	JS160 JS175 JS180LC JS190	61	D20
	JS220 JS245X	62	D30
KATO IMER IHI	HD823MR-7	62	D40
KOBELCO ⁽¹⁾	SK180LC-11	61	D20
	SK230SRLC-7	61	D30
	SK270SRNLC-7	62	D30

BRAND	MACHINES	BUCKET RANGE	TINE CLASS
KOBELCO ⁽¹⁾	SK210LC-11 SK260SRNLC-3 SK260LC-11	62	D40
	SK270SRLC-5 SK270SRNLC-5	62	D30
KOMATSU	PC170LC-11 PW180-11 PW198-11	61	D20
	HB215	62	D30
	PC210LC/LNC-11 PC240LC/NLC-11	62	D40
LIEBHERR	A918Li/Compact R918Li R920Compact	61	D20
	A920litronic	61	D30
	A/R922 LH35M R920 R924Compact R926Compact A902LITRONIC A904 R912LITRONIC R904C R912 R2922LI DEMOL	62	D30
	A924litronic A928litronic R922G8 R924 (3B) R926 SEALED BEARING	62	D40
	R926 Classic-Advanced R924G8 R926-III-IV-V	63	D40
LIUGONG	CLG922E	61	D30
	926F	62	D30
	925E	62	D40
SANY	SY215C	62	D40
VOLVO	EC180E EW170E EW160E	61	D20
	EW180E	61	D30
	ECR235E	62	D30
	EC200EL EC220E	62	D40
	EC240/B/C EC250E	63	D40

HD BACKHOES RANGE 6I TBI

Morin Original system coupler M6
for machines from 15t to 24t
Couplers available on pages 18 to 30

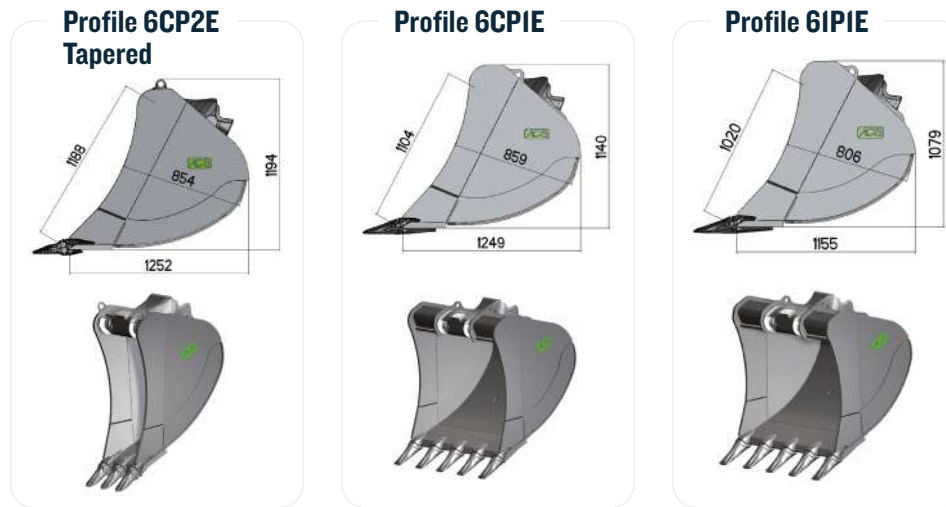

• Represents the range of breakout forces the tooth can withstand. To see the correspondence table, go to page 13.

Thickness = Blade thickness | (*) Weight variation +/- 2% depending on equipment | Total weight = (ISO capacity in l x Density 1.8) + Bucket weight in kg | Average tooth count

Specially designed for construction and renovation work, HD BUCKETS offer the best performance for your application. The standard HD version can be reinforced with shields, side cutters, corner protectors, skids, plates, etc.

Bucket with teeth



PART NUMBER	WIDTH (mm)	ISO CAPACITY (l)	BUCKET WEIGHT (kg)*	TOTAL WEIGHT (kg)	PRICE EXCL. VAT (€)	NUMBER OF TEETH	ITEM CODE	NUMBER OF TEETH	ITEM CODE	NUMBER OF TEETH	ITEM CODE
R-6CP2E-400	400	433	478	1257	-	2	K80	3	R14GPE	2	U25S
R-6CP2E-500	500	386	477	1172	-	2	5076693	3	R14GPE	3	5074208
R-6CPIE-620	620	492	550	1436	-	3	5067559	3	R14GPE	3	5068882
R-6CPIE-700	700	518	520	1452	-	3	K80	4	R14GPE	3	U25S
R-6CPIE-800	800	596	579	1652	-	3	5070186	4	R14GPE	4	5087953
R-6CPIE-900	900	697	619	1874	-	4	K80	5	R14GPE	4	5067834
R6I-PIE-1000	1000	719	738	2032	-	4	K80	5	R14GPE	4	5068883
R6I-PIE-1100	1100	812	683	2145	-	5	5094360	5	R14GPE	5	5069860
R6I-PIE-1200	1200	905	727	2356	-	5	5070169	6	R14GPE	5	5071821
R6I-PIE-1300	1300	999	764	2562	-	5	5067987	6	R14GPE	5	5087943

Profile 6CP2E Tapered

Profile 6CPIE

HD BACKHOES RANGE 61 TBI

Morin Original system coupler M6
for machines from 15t to 24t
Couplers available on pages 18 to 30

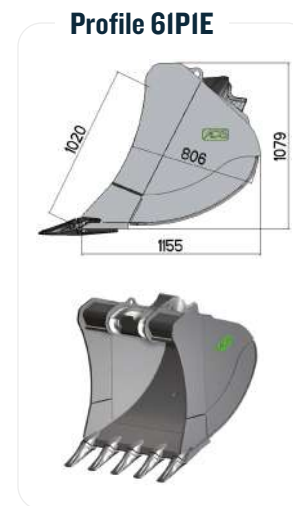

• Represents the range of breakout forces the tooth can withstand. To see the correspondence table, go to page 13.

Thickness = Blade thickness | (*) Weight variation +/- 2% depending on equipment | Total weight = (ISO capacity in l x Density 1.8) + Bucket weight in kg | Average tooth count

Bucket with teeth



PART NUMBER	WIDTH (mm)	ISO CAPACITY (l)	BUCKET WEIGHT (kg)*	TOTAL WEIGHT (kg)	PRICE EXCL. VAT (€)	NUMBER OF TEETH	ITEM CODE	NUMBER OF TEETH	ITEM CODE
R-6CP2E-400	400	433	478	1257	-	2	FK4TLR	2	5079281
R-6CP2E-500	500	386	477	1172	-	3	FK4TLR	3	FT230S
R-6CP1E-620	620	492	529	1415	-	3	5074223	3	5076806
R-6CP1E-700	700	518	520	1452	-	4	FK4TLR	3	FT230S
R-6CP1E-800	800	596	565	1638	-	4	5077433	4	5092727
R-6CP1E-900	900	697	664	1919	-	4	FK4TLR	4	FT230S
R61-PIE-1000	1000	719	738	2032	-	5	FK4TLR	4	FT230S
R61-PIE-1100	1100	812	683	2145	-	5	5108004	5	FT230S
R61-PIE-1200	1200	905	690	2319	-	5	5074224	5	5076773
R61-PIE-1300	1300	999	764	2562	-	6	5124576	6	FT230S

Profile 6CP2E Tapered

Profile 6CP1E

HD BACKHOES RANGE 6I TB2

Morin Original system coupler M6
for machines from 15t to 24t
Couplers available on pages 18 to 30

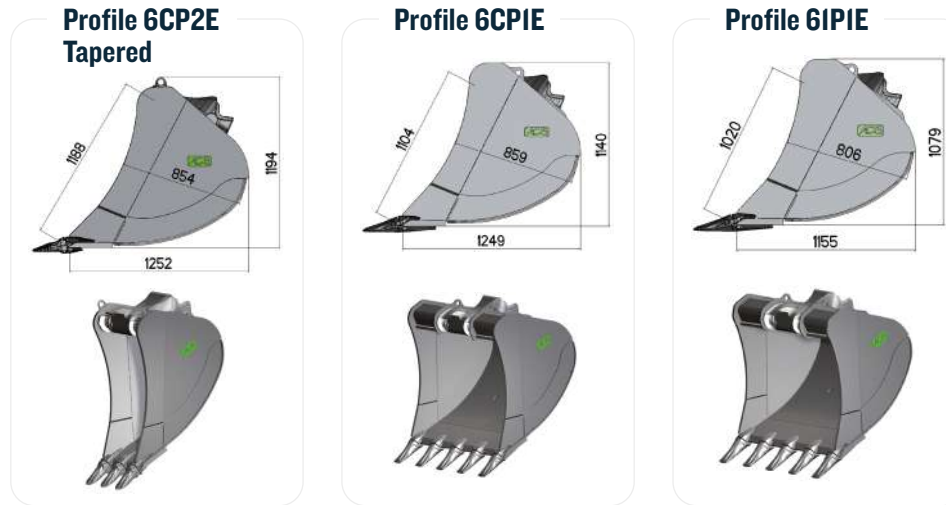

• Represents the range of breakout forces the tooth can withstand. To see the correspondence table, go to page 13.

Thickness = Blade thickness | (*) Weight variation +/- 2% depending on equipment | Total weight = (ISO capacity in l x Density 1.8) + Bucket weight in kg | Average tooth count

Specially designed for construction and renovation work, HD BUCKETS offer the best performance for your application. The standard HD version can be reinforced with shields, side cutters, corner protectors, skids, plates, etc.

Bucket with teeth



PART NUMBER	WIDTH (mm)	ISO CAPACITY (l)	BUCKET WEIGHT (kg)*	TOTAL WEIGHT (kg)	PRICE EXCL. VAT (€)	NUMBER OF TEETH	ITEM CODE	NUMBER OF TEETH	ITEM CODE	NUMBER OF TEETH	ITEM CODE
R-6CP2E-400	400	433	495	1274	-	2	1U3352	2	CA90	2	5074575
R-6CP2E-500	500	386	489	1184	-	3	1U3352	2	CA90	2	5076733
R-6CPIE-620	620	492	553	1439	-	3	5070098	3	CA90	3	5068040
R-6CPIE-700	700	518	563	1495	-	3	5125651	3	CA90	3	5094035
R-6CPIE-800	800	596	596	1669	-	4	5124145	3	CA90	4	5082402
R-6CPIE-900	900	697	658	1913	-	4	1U3352	4	CA90	4	5064716
R6I-P1E-1000	1000	719	639	1933	-	4	5065363	4	CA90	4	5064245
R6I-P1E-1100	1100	812	675	2137	-	5	1U3352	4	CA90	4	5065934
R6I-P1E-1200	1200	905	731	2360	-	5	5085307	4	CA90	5	5065906
R6I-P1E-1300	1300	999	769	2567	-	5	5093478	5	CA90	5	5065977

Profile 6CP2E Tapered

Profile 6CPIE

HD BACKHOES RANGE 61 TB2

Morin Original system coupler M6
for machines from 15t to 24t
Couplers available on pages 18 to 30

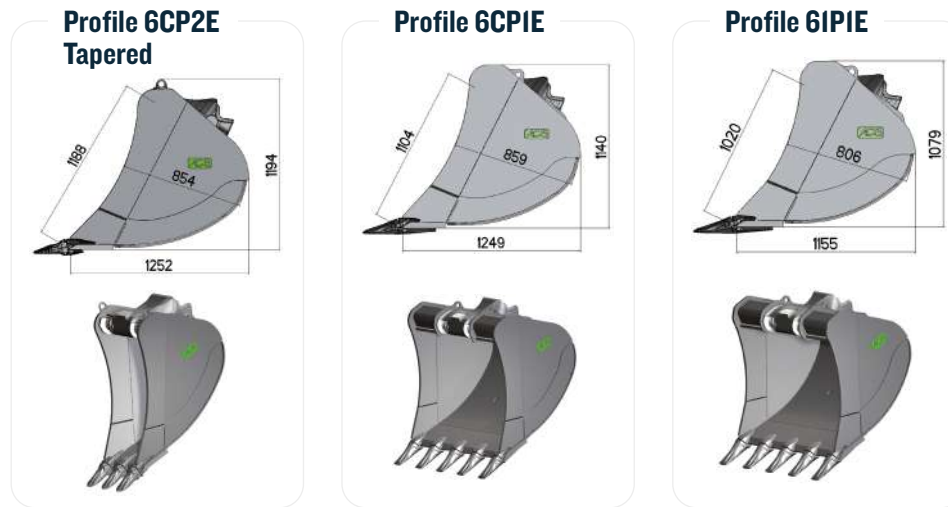

• Represents the range of breakout forces the tooth can withstand. To see the correspondence table, go to page 13.

Thickness = Blade thickness | (*) Weight variation +/- 2% depending on equipment | Total weight = (ISO capacity in l x Density 1.8) + Bucket weight in kg | Average tooth count

Bucket with teeth



PART NUMBER	WIDTH (mm)	ISO CAPACITY (l)	BUCKET WEIGHT (kg)*	TOTAL WEIGHT (kg)	PRICE EXCL. VAT (€)	NUMBER OF TEETH	ITEM CODE	NUMBER OF TEETH	ITEM CODE	NUMBER OF TEETH	ITEM CODE
R-6CP2E-400	400	433	523	1302	-	2	5089565	2	FT290S	2	P020SC
R-6CP2E-500	500	386	507	1202	-	3	5070736	3	5093408	2	P020SC
R-6CPIE-620	620	492	555	1441	-	3	5070355	3	5079727	3	P020SC
R-6CPIE-700	700	518	563	1495	-	3	5070737	3	5085781	3	P020SC
R-6CPIE-800	800	596	590	1663	-	4	5070380	4	FT290S	3	P020SC
R-6CPIE-900	900	697	663	1918	-	4	5149343	4	FT290S	4	P020SC
R61-PIE-1000	1000	719	620	1914	-	4	5136396	4	FT290S	4	P020SC
R61-PIE-1100	1100	812	679	2141	-	5	5131926	4	5093409	4	P020SC
R61-PIE-1200	1200	905	712	2341	-	5	5070738	5	FT290S	5	P020SC
R61-PIE-1300	1300	999	773	2571	-	6	5124887	5	5078267	5	P020SC

Profile 6CP2E Tapered

Profile 6CPIE

HD BACKHOES RANGE 61 TB2

Morin Original system coupler M6
for machines from 15t to 24t
Couplers available on pages 18 to 30

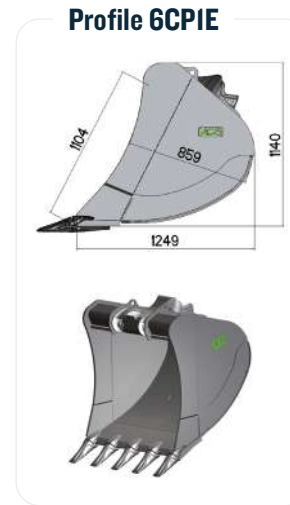

• Represents the range of breakout forces the tooth can withstand. To see the correspondence table, go to page 13.

Thickness = Blade thickness | (*) Weight variation +/- 2% depending on equipment | Total weight = (ISO capacity in l x Density 1.8) + Bucket weight in kg | Average tooth count

Bucket with teeth



PART NUMBER	WIDTH (mm)	ISO CAPACITY (l)	BUCKET WEIGHT (kg)*	TOTAL WEIGHT (kg)	PRICE EXCL. VAT (€)	NUMBER OF TEETH	ITEM CODE	NUMBER OF TEETH	ITEM CODE
R-6CP2E-400	400	433	523	1302	-	2	MA20U	2	20GPE
R-6CP2E-500	500	386	507	1202	-	3	5150485	3	20GPE
R-6CPIE-620	620	492	555	1441	-	3	5131017	3	5093816
R-6CPIE-700	700	518	563	1495	-	3	MA20U	3	5109524
R-6CPIE-800	800	596	590	1663	-	4	5135627	3	20GPE
R-6CPIE-900	900	697	663	1918	-	4	MA20U	4	20GPE
R61-P1E-1000	1000	719	620	1914	-	4	MA20U	4	20GPE
R61-P1E-1100	1100	812	679	2141	-	5	MA20U	5	20GPE
R61-P1E-1200	1200	905	712	2341	-	5	5140778	5	5120771
R61-P1E-1300	1300	999	773	2571	-	5	MA20U	5	20GPE

Profile 6CP2E
Tapered

Profile 6CPIE

HD BACKHOES RANGE 61 TB3

Morin Original system coupler M6
for machines from 15t to 24t
Couplers available on pages 18 to 30

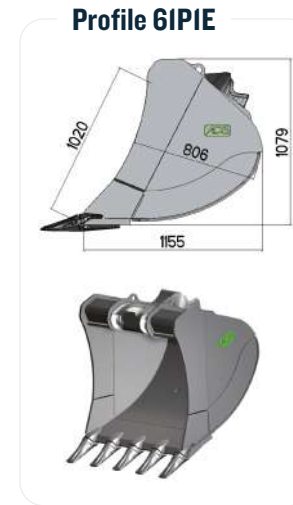

• Represents the range of breakout forces the tooth can withstand. To see the correspondence table, go to page 13.

Thickness = Blade thickness | (*) Weight variation +/- 2% depending on equipment | Total weight = (ISO capacity in l x Density 1.8) + Bucket weight in kg | Average tooth count

Bucket with teeth



PART NUMBER	WIDTH (mm)	ISO CAPACITY (l)	BUCKET WEIGHT (kg)*	TOTAL WEIGHT (kg)	PRICE EXCL. VAT (€)	NUMBER OF TEETH	ITEM CODE	NUMBER OF TEETH	ITEM CODE
R-6CP2E-400	400	433	510	1289	-	2	R23GPE	2	U35S
R-6CP2E-500	500	386	507	1202	-	3	R23GPE	2	5108080
R-6CP1E-620	620	492	562	1448	-	3	R23GPE	3	5062801
R-6CP1E-700	700	518	571	1503	-	3	R23GPE	3	5066079
R-6CP1E-800	800	596	607	1680	-	4	R23GPE	3	5066160
R-6CP1E-900	900	697	672	1927	-	4	R23GPE	4	5070530
R61-PIE-1000	1000	719	620	1914	-	4	R23GPE	4	U35S
R61-PIE-1100	1100	812	645	2107	-	5	R23GPE	4	5139647
R61-PIE-1200	1200	905	749	2378	-	5	R23GPE	4	5118013
R61-PIE-1300	1300	999	787	2585	-	5	R23GPE	5	5106744

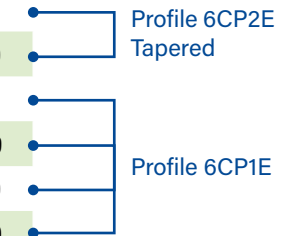

HD BACKHOES RANGE 6I TB3

Morin Original system coupler M6
for machines from 15t to 24t
Couplers available on pages 18 to 30

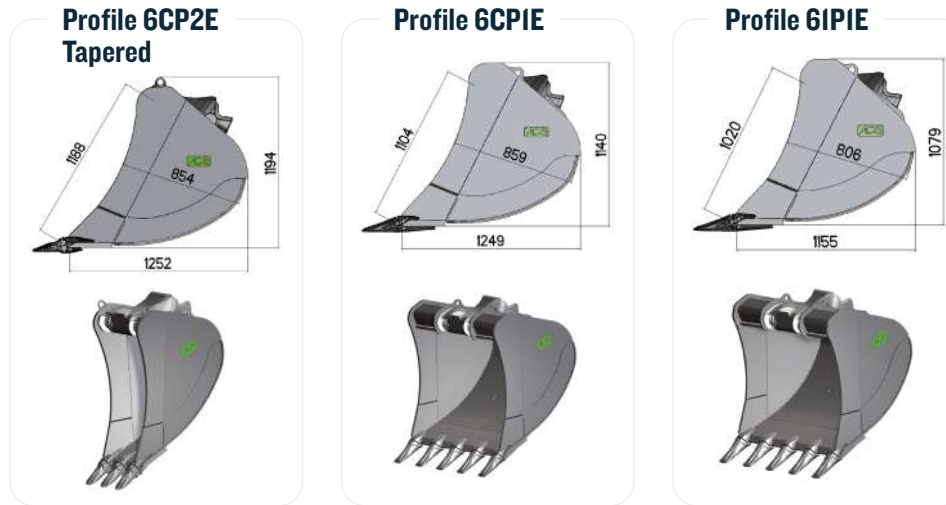

• Represents the range of breakout forces the tooth can withstand. To see the correspondence table, go to page 13.

Thickness = Blade thickness | (*) Weight variation +/- 2% depending on equipment | Total weight = (ISO capacity in l x Density 1.8) + Bucket weight in kg | Average tooth count

Specially designed for construction and renovation work, HD BUCKETS offer the best performance for your application. The standard HD version can be reinforced with shields, side cutters, corner protectors, skids, plates, etc.

Bucket with teeth



PART NUMBER	WIDTH (mm)	ISO CAPACITY (l)	BUCKET WEIGHT (kg)*	TOTAL WEIGHT (kg)	PRICE EXCL. VAT (€)	NUMBER OF TEETH	ITEM CODE	NUMBER OF TEETH	ITEM CODE	NUMBER OF TEETH	ITEM CODE
R-6CP2E-400	400	433	510	1289	-	2	5117997	2	SD7TLR	2	FT330S
R-6CP2E-500	500	386	507	1202	-	3	5124577	2	SD7TLR	2	5100294
R-6CPIE-620	620	492	562	1448	-	3	5075666	3	5075656	3	5125821
R-6CPIE-700	700	518	590	1503	-	3	5131739	3	5111263	3	FT330S
R-6CPIE-800	800	596	607	1680	-	3	5128133	3	5142322	3	5100293
R-6CPIE-900	900	697	672	1927	-	4	5149442	4	SD7TLR	4	FT330S
R61-PIE-1000	1000	719	620	1914	-	4	FK7TLR	4	SD7TLR	4	FT330S
R61-PIE-1100	1100	812	645	2107	-	5	FK7TLR	4	SD7TLR	4	FT330S
R61-PIE-1200	1200	905	749	2378	-	5	FK7TLR	4	SD7TLR	4	FT330S
R61-PIE-1300	1300	999	787	2585	-	5	FK7TLR	5	SD7TLR	5	FT330S

Profile 6CP2E Tapered

Profile 6CPIE

HD BACKHOES RANGE 62 TBI

Morin Original system coupler M6
for machines from 15t to 24t
Couplers available on pages 18 to 30

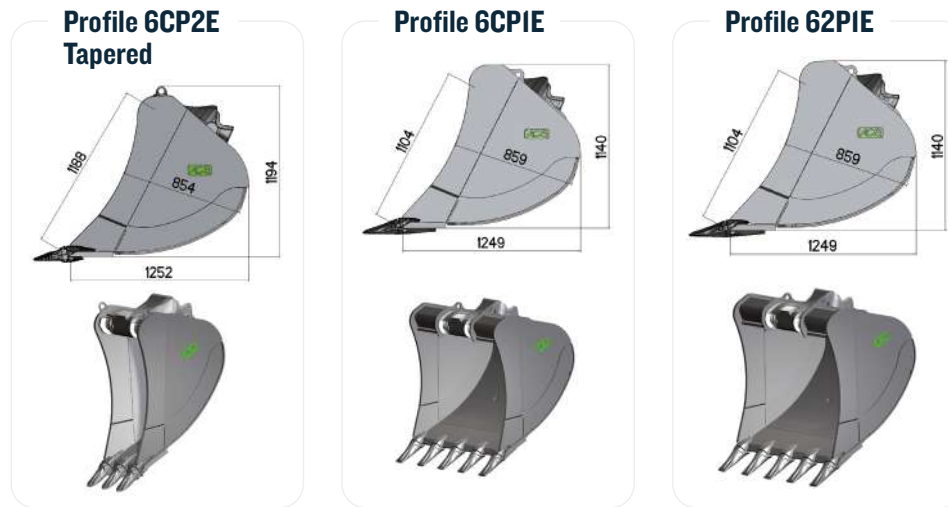

• Represents the range of breakout forces the tooth can withstand. To see the correspondence table, go to page 13.

Thickness = Blade thickness | (*) Weight variation +/- 2% depending on equipment | Total weight = (ISO capacity in l x Density 1.8) + Bucket weight in kg | Average tooth count

Bucket with teeth



PART NUMBER	WIDTH (mm)	ISO CAPACITY (l)	BUCKET WEIGHT (kg)*	TOTAL WEIGHT (kg)	PRICE EXCL. VAT (€)	NUMBER OF TEETH	ITEM CODE	NUMBER OF TEETH	ITEM CODE	NUMBER OF TEETH	ITEM CODE
R-6CP2E-400	400	433	495	1274	-	2	1U3352	2	5074575	2	5089565
R-6CP2E-500	500	386	489	1184	-	2	1U3352	2	5076733	3	5070736
R-6CP1E-620	620	492	553	1439	-	3	5070098	3	5068040	3	5070355
R-6CP1E-700	700	518	563	1495	-	3	5125651	3	5094035	3	5070737
R-6CP1E-800	800	596	596	1669	-	4	5124145	4	5082402	4	5070380
R-6CP1E-900	900	697	658	1913	-	4	1U3352	4	5064716	4	5149343
R62-PIE-1000	1000	837	709	2216	-	4	5116263	4	5065471	4	5135819
R62-PIE-1200	1200	1058	811	2715	-	5	5139284	5	5064703	5	5070382
R62-PIE-1300	1300	1168	854	2956	-	5	5069894	5	5066339	5	5070378
R62-PIE-1400	1400	1279	896	3198	-	5	5070717	5	5068033	6	5070896

Profile 6CP2E Tapered

Profile 6CP1E

HD BACKHOES RANGE 62 TBI

Morin Original system coupler M6
for machines from 15t to 24t
Couplers available on pages 18 to 30



• Represents the range of breakout forces the tooth can withstand. To see the correspondence table, go to page 13.

Thickness = Blade thickness | (*) Weight variation +/- 2% depending on equipment | Total weight = (ISO capacity in l x Density 1.8) + Bucket weight in kg | Average tooth count

Specially designed for construction and renovation work, HD BUCKETS offer the best performance for your application. The standard HD version can be reinforced with shields, side cutters, corner protectors, skids, plates, etc.

Bucket with teeth



PART NUMBER	WIDTH (mm)	ISO CAPACITY (l)	BUCKET WEIGHT (kg)*	TOTAL WEIGHT (kg)	PRICE EXCL. VAT (€)	NUMBER OF TEETH	ITEM CODE	NUMBER OF TEETH	ITEM CODE	NUMBER OF TEETH	ITEM CODE
R-6CP2E-400	400	433	491	1270	-	2	FT290S	2	MA20U	2	21GPE
R-6CP2E-500	500	386	507	1202	-	3	5093408	3	5150485	3	21GPE
R-6CPIE-620	620	492	555	1441	-	3	5079727	3	5131017	3	21GPE
R-6CPIE-700	700	518	563	1495	-	3	5085781	3	MA20U	3	21GPE
R-6CPIE-800	800	596	588	1661	-	4	FT290S	4	5135627	3	21GPE
R-6CPIE-900	900	697	663	1918	-	4	FT290S	4	MA20U	4	21GPE
R62-PIE-1000	1000	837	701	2208	-	4	FT290S	4	5150436	4	21GPE
R62-PIE-1200	1200	1058	815	2719	-	5	5078437	5	5150486	5	21GPE
R62-PIE-1300	1300	1168	860	2963	-	5	5088038	5	MA20U	5	21GPE
R62-PIE-1400	1400	1279	904	3206	-	5	5076740	5	5135394	5	21GPE

Profile 6CP2E Tapered

Profile 6CPIE

HD BACKHOES RANGE 62 TB2

Morin Original system coupler M6
for machines from 15t to 24t
Couplers available on pages 18 to 30



• Represents the range of breakout forces the tooth can withstand. To see the correspondence table, go to page 13.

Thickness = Blade thickness | (*) Weight variation +/- 2% depending on equipment | Total weight = (ISO capacity in l x Density 1.8) + Bucket weight in kg | Average tooth count

Bucket with teeth

CAT CA90 220-9099

Thickness 40 mm • D30



C-REX R23GPE

Thickness 40 mm • D40



ESCO U35S

Thickness 40 mm • D40



PART NUMBER	WIDTH (mm)	ISO CAPACITY (l)	BUCKET WEIGHT (kg)*	TOTAL WEIGHT (kg)	PRICE EXCL. VAT (€)	NUMBER OF TEETH	ITEM CODE	NUMBER OF TEETH	ITEM CODE	NUMBER OF TEETH	ITEM CODE
R-6CP2E-400	400	433	504	1283	-	2	CA90	2	R23GPE	2	U35S
R-6CP2E-500	500	386	500	1195	-	3	CA90	3	R23GPE	2	5108080
R-6CP1E-620	620	492	562	1448	-	3	CA90	3	R23GPE	3	5062801
R-6CP1E-700	700	518	571	1503	-	3	CA90	3	R23GPE	3	5066079
R-6CP1E-800	800	596	608	1681	-	3	CA90	4	R23GPE	3	5066160
R-6CP1E-900	900	697	672	1927	-	4	CA90	4	R23GPE	4	5070530
R62-PIE-1000	1000	837	744	2251	-	4	CA90	4	R23GPE	4	5130157
R62-PIE-1200	1200	1058	828	2732	-	4	CA90	5	R23GPE	4	5067505
R62-PIE-1300	1300	1168	871	2973	-	5	CA90	5	5139845	5	5067501
R62-PIE-1400	1400	1279	929	3231	-	5	CA90	6	R23GPE	5	5056924

Profile 6CP2E Tapered

Profile 6CP1E

HD BACKHOES RANGE 62 TB2

Morin Original system coupler M6
for machines from 15t to 24t
Couplers available on pages 18 to 30



• Represents the range of breakout forces the tooth can withstand. To see the correspondence table, go to page 13.

Thickness = Blade thickness | (*) Weight variation +/- 2% depending on equipment | Total weight = (ISO capacity in l x Density 1.8) + Bucket weight in kg | Average tooth count

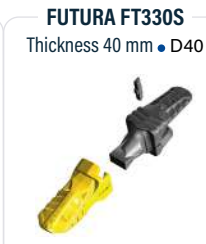

Bucket with teeth

PART NUMBER	WIDTH (mm)	ISO CAPACITY (l)	BUCKET WEIGHT (kg)*	TOTAL WEIGHT (kg)	PRICE EXCL. VAT (€)	NUMBER OF TEETH	ITEM CODE	NUMBER OF TEETH	ITEM CODE	NUMBER OF TEETH	ITEM CODE	NUMBER OF TEETH	ITEM CODE
R-6CP2E-400	400	433	512	1291	-	2	5117997	2	SD7TLR	2	FT330S	2	5150457
R-6CP2E-500	500	386	507	1202	-	2	5124577	2	SD7TLR	2	5100294	2	MA30U
R-6CPIE-620	620	492	581	1467	-	3	5075666	3	5075666	3	5125821	3	5103978
R-6CPIE-700	700	518	583	1515	-	3	5131739	3	5111263	3	FT330S	3	MA30U
R-6CPIE-800	800	596	607	1680	-	3	5128133	3	5142322	3	5100293	3	MA30U
R-6CPIE-900	900	697	688	1943	-	4	5149442	4	SD7TLR	4	FT330S	4	5150458
R62-PIE-1000	1000	837	760	2267	-	4	FK7TLR	4	SD7TLR	4	FT330S	4	MA30U
R62-PIE-1200	1200	1058	832	2736	-	5	5086901	4	SD7TLR	4	5088375	5	5150449
R62-PIE-1300	1300	1168	904	3006	-	5	5075665	5	5072332	5	FT330S	5	5105253
R62-PIE-1400	1400	1279	938	3240	-	5	5064682	5	5069491	5	5079273	6	5089467

Profile 6CP2E Tapered

Profile 6CPIE

HD BACKHOES RANGE 63 TBI

Morin Original system coupler M6
for machines from 15t to 24t
Couplers available on pages 18 to 30

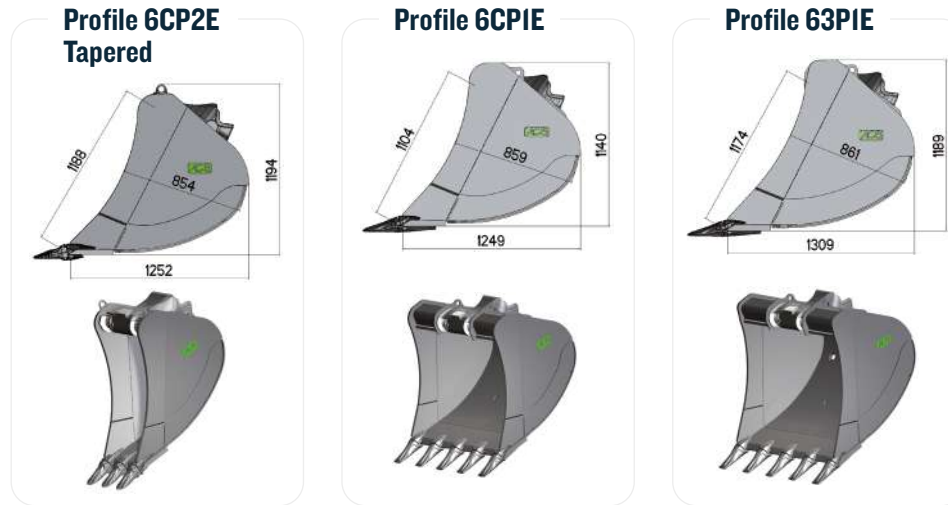

• Represents the range of breakout forces the tooth can withstand. To see the correspondence table, go to page 13.

Thickness = Blade thickness | (*) Weight variation +/- 2% depending on equipment | Total weight = (ISO capacity in l x Density 1.8) + Bucket weight in kg | Average tooth count

Bucket with teeth



PART NUMBER	WIDTH (mm)	ISO CAPACITY (l)	BUCKET WEIGHT (kg)*	TOTAL WEIGHT (kg)	PRICE EXCL. VAT (€)	NUMBER OF TEETH	ITEM CODE	NUMBER OF TEETH	ITEM CODE	NUMBER OF TEETH	ITEM CODE
R-6CP2E-400	400	433	508	1287	-	2	U35S	2	5117997	2	5150457
R-6CP2E-500	500	386	504	1199	-	2	5108080	3	5124577	3	MA30U
R-6CP1E-620	620	492	569	1455	-	3	5062801	3	5075666	3	MA30U
R-6CP1E-700	700	518	581	1513	-	3	5066079	3	5131739	3	MA30U
R-6CP1E-800	800	596	603	1676	-	3	5066160	3	5128133	3	MA30U
R-6CP1E-900	900	697	685	1940	-	4	5070530	4	5149442	4	5150458
R63-PIE-1000	1000	837	752	2259	-	4	U35S	4	FK7TLR	4	MA30U
R63-PIE-1200	1200	1125	847	2872	-	4	5079732	4	5121608	4	MA30U
R63-PIE-1400	1400	1362	954	3406	-	5	5062892	5	5077532	6	5142280
R63-PIE-1500	1500	1481	999	3665	-	5	5061167	5	5114937	6	5111544
R63-PIE-1600	1600	1599	1055	3933	-	5	U35S	5	FK7TLR	6	5131768

Profile 6CP2E Tapered

Profile 6CP1E

BANANA BUCKETS

Morin Original system coupler M6 for machines from 15t to 24t
Couplers available on pages 18 to 30

TINES	ITEM CODE	TINE CLASS	BLADE THICKNESS
PRICE TB1			
CAT	K80	D20	35 mm
C-REX	R14GPE	D20	40 mm
ESCO	U25S	D20	30 mm
FEURST	FK4TLR	D30	30 mm
FUTURA	FT230S	D20	30 mm
PRICE TB2			
CAT	K90	D30	40 mm
C-REX	R23GPE	D40	40 mm
ESCO	U30S	D30	35 mm
FEURST	FK5TLR	D40	35 mm
FUTURA	FT290S	D30	35 mm
KOMATSU	PO20RC	D30	40 mm
MTG	MA20U	D20	40 mm
VOLVO	20GPE	D20	40 mm
PRICE TB3			
CAT	J350 1U3352	D30	40 mm
ESCO	U35S	D40	40 mm
FEURST	26TLR	D40	40 mm
FEURST	FK7TLR	D40	40 mm
FEURST	SD7TLR	D40	40 mm
FUTURA	FT330S	D40	40 mm

Thanks to its narrow width, the BANANA BUCKET is ideal for work requiring precision, such as small trenches or cable installation.

TINE CLASS: represents the range of break out forces the tooth can withstand. To see the correspondence table, go to page 13.

Thickness = Blade thickness - (*) Weight variation of +/- 5% depending on equipment - Total weight = (ISO capacity in l x Density 1.8) + Bucket weight in kg | Average number of teeth

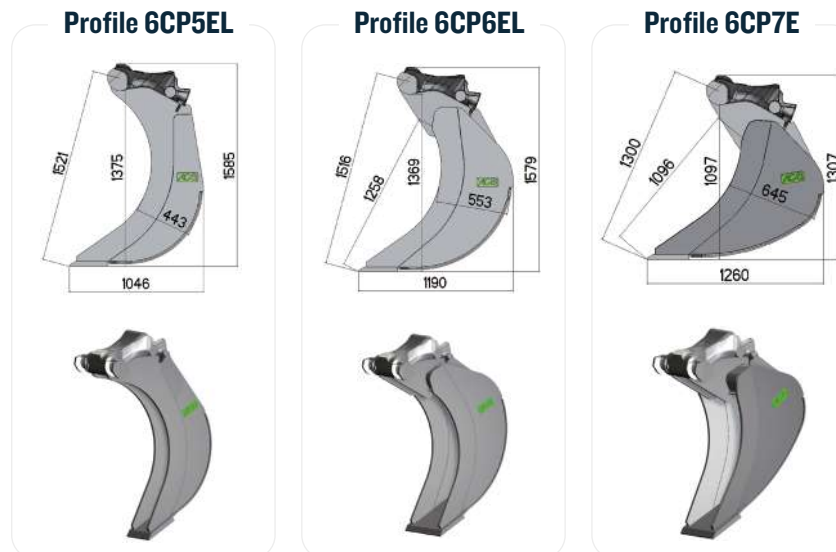

Profile 6CP5EL

PART NUMBER	WIDTH (mm)	ISO CAPACITY (l)	BUCKET WEIGHT (kg)*	TOTAL WEIGHT (kg)	PRICE EXCL. VAT TB1 (€)	PRICE EXCL. VAT TB2 (€)	PRICE EXCL. VAT TB3 (€)
6GL-6CP5EL-250	250	142	374	630	-	-	-
6GL-6CP5EL-300	300	142	379	635	-	-	-

Profile 6CP6EL

PART NUMBER	WIDTH (mm)	ISO CAPACITY (l)	BUCKET WEIGHT (kg)*	TOTAL WEIGHT (kg)	PRICE EXCL. VAT TB1 (€)	PRICE EXCL. VAT TB2 (€)	PRICE EXCL. VAT TB3 (€)
6GL-6CP6EL-400	400	160	461	749	-	-	-
6GL-6CP6EL-500	500	234	506	927	-	-	-

Profile 6CP7E

PART NUMBER	WIDTH (mm)	ISO CAPACITY (l)	BUCKET WEIGHT (kg)*	TOTAL WEIGHT (kg)	PRICE EXCL. VAT TB1 (€)	PRICE EXCL. VAT TB2 (€)	PRICE EXCL. VAT TB3 (€)
6GL-6CP7E-350	350	199	450	808	-	-	-
6GL-6CP7E-450	450	239	496	926	-	-	-

FIXED DITCH CLEANING BUCKETS

Morin Original system coupler M6
for machines from 15t to 24t
Couplers available on pages 18 to 30

The ditch cleaning bucket can be used for finishing work such as ditch cleaning, embanking, levelling and much more.

Thickness = Blade thickness | (*) Weight variation +/- 2% depending on equipment | Total weight = (ISO capacity in l x Density 1.8) + Bucket weight in kg

Profile 6CPIE

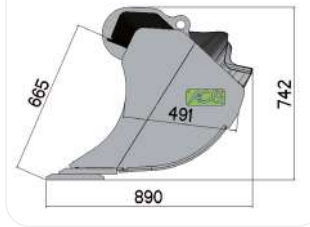

REVERSIBLE BOLT-ON COUNTER-BLADE

Thickness 25 mm



REVERSIBLE BOLT-ON COUNTER-BLADE + REAR BLADE

Thickness 25 mm



Profile 6CPIE

PART NUMBER	WIDTH (mm)	ISO CAPACITY (l)	BUCKET WEIGHT (kg)*	TOTAL WEIGHT (kg)	PRICE EXCL. VAT (€)	ITEM CODE	BUCKET WEIGHT (kg)*	TOTAL WEIGHT (kg)	PRICE EXCL. VAT (€)	ITEM CODE
CM6-1800-6CPIE	1800	533	689	1648	-	5077444	750	1709	-	5075523
CM6-2000-6CPIE	2000	597	747	1822	-	5074003	817	1892	-	5071887
CM6-2200-6CPIE	2200	660	805	1993	-	5072962	882	2070	-	5072220
CM6-2400-6CPIE	2400	724	865	2168	-	5085336	948	2251	-	5066119

Profile 6CP2E

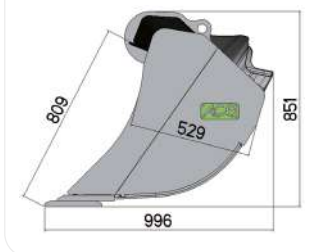

REVERSIBLE BOLT-ON COUNTER-BLADE

Thickness 25 mm



REVERSIBLE BOLT-ON COUNTER-BLADE + REAR BLADE

Thickness 25 mm



Profile 6CP2E

PART NUMBER	WIDTH (mm)	ISO CAPACITY (l)	BUCKET WEIGHT (kg)*	TOTAL WEIGHT (kg)	PRICE EXCL. VAT (€)	ITEM CODE	BUCKET WEIGHT (kg)*	TOTAL WEIGHT (kg)	PRICE EXCL. VAT (€)	ITEM CODE
CM6-1800-6CP2E	1800	743	750	2087	-	5070513	814	2151	-	5085308
CM6-2000-6CP2E	2000	870	812	2378	-	5067988	883	2449	-	5071067
CM6-2200-6CP2E	2200	964	875	2610	-	5071945	953	2688	-	5069921
CM6-2400-6CP2E	2400	1058	938	2842	-	5091134	1024	2928	-	5063429

FIXED DITCH CLEANING BUCKETS

Morin Original system coupler M6
for machines from 15t to 24t
Couplers available on pages 18 to 30

The ditch cleaning bucket can be used for finishing work such as ditch cleaning, embanking, levelling and much more.

Thickness = Blade thickness | (*) Weight variation +/- 2% depending on equipment | Total weight = (ISO capacity in l x Density 1.8) + Bucket weight in kg

Profile 6CP3E



REVERSIBLE BOLT-ON COUNTER-BLADE

Thickness 25 mm



REVERSIBLE BOLT-ON COUNTER-BLADE

+ REAR BLADE

Thickness 25 mm



Profile 6CP3E

PART NUMBER	WIDTH (mm)	ISO CAPACITY (l)	BUCKET WEIGHT (kg)*	TOTAL WEIGHT (kg)	PRICE EXCL. VAT (€)	ITEM CODE	BUCKET WEIGHT (kg)*	TOTAL WEIGHT (kg)	PRICE EXCL. VAT (€)	ITEM CODE
CM6-1800-6CP3E	1800	970	812	2558	-	5086213	875	2621	-	5100295
CM6-2000-6CP3E	2000	1086	879	2834	-	5068034	950	2905	-	5070610
CM6-2200-6CP3E	2200	1205	946	3115	-	5070531	1024	3193	-	5069917
CM6-2400-6CP3E	2400	1323	1013	3394	-	5070254	1099	3480	-	5066169

TILT DITCH CLEANING BUCKETS

Morin Original system coupler M6
for machines from 15t to 24t
Couplers available on pages 18 to 30

The TILTING BUCKET can be used for finishing work such as ditch cleaning, embanking, levelling and much more. The tilting version is stable on the ground and remains upright to facilitate the next attachment.

Thickness = Blade thickness | (*) Weight variation +/- 2% depending on equipment | Total weight = (ISO capacity in l x Density 1.8) + Bucket weight in kg

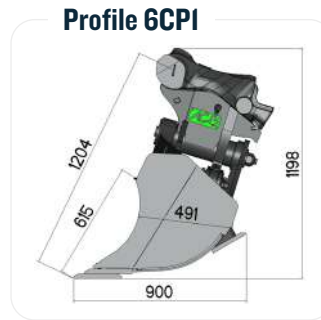
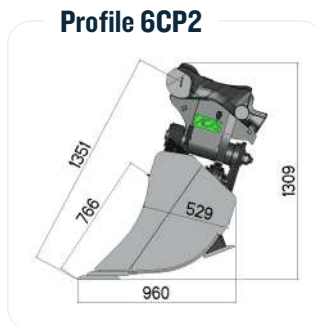

Profile 6CPI 2 x 45° - 2 Cylinders



PART NUMBER	WIDTH (mm)	ISO CAPACITY (l)	BUCKET WEIGHT (kg)*	TOTAL WEIGHT (kg)	PRICE EXCL. VAT (€)	ITEM CODE	BUCKET WEIGHT (kg)*	TOTAL WEIGHT (kg)	PRICE EXCL. VAT (€)	ITEM CODE
6CPI-1800	1800	502	932	1836	-	5113333	992	1896	-	5078025
6CPI-2000	2000	562	991	2003	-	5114652	1061	2073	-	5067196
6CPI-2200	2200	622	1045	2165	-	5083621	1122	2242	-	5075643
6CPI-2400	2400	682	1140	2368	-	RBCB	1225	2453	-	LAR
6CPI-2500	2500	712	1190	2472	-	RBCB	1280	2562	-	5100434



Profile 6CP2 2 x 45° - 2 Cylinders

PART NUMBER	WIDTH (mm)	ISO CAPACITY (l)	BUCKET WEIGHT (kg)*	TOTAL WEIGHT (kg)	PRICE EXCL. VAT (€)	ITEM CODE	BUCKET WEIGHT (kg)*	TOTAL WEIGHT (kg)	PRICE EXCL. VAT (€)	ITEM CODE
6CP2-1800	1800	744	990	2329	-	5078570	1053	2392	-	5069550
6CP2-2000	2000	834	1049	2550	-	5082325	1120	2621	-	5067928
6CP2-2200	2200	923	1108	2769	-	5104944	1185	2846	-	5067197
6CP2-2400	2400	1013	1167	2990	-	5123425	1254	3077	-	5081099
6CP2-2500	2500	1045	1194	3075	-	RBCB	1284	3165	-	5081086

TILT DITCH CLEANING BUCKETS

Morin Original system coupler M6
for machines from 15t to 24t
Couplers available on pages 18 to 30

The TILTING BUCKET can be used for finishing work such as ditch cleaning, embanking, levelling and much more. The tilting version is stable on the ground and remains upright to facilitate the next attachment.

Thickness = Blade thickness | (*) Weight variation +/- 2% depending on equipment | Total weight = (ISO capacity in l x Density 1.8) + Bucket weight in kg

Profile 6CP3



Profile 6CP3 2 x 45° - 2 Cylinders

REVERSIBLE BOLT-ON COUNTER-BLADE

Thickness 25 mm



REVERSIBLE BOLT-ON COUNTER-BLADE
+ REAR BLADE

Thickness 25 mm



PART NUMBER	WIDTH (mm)	ISO CAPACITY (l)	BUCKET WEIGHT (kg)*	TOTAL WEIGHT (kg)	PRICE EXCL. VAT (€)	ITEM CODE	BUCKET WEIGHT (kg)*	TOTAL WEIGHT (kg)	PRICE EXCL. VAT (€)	ITEM CODE
6CP3-1800	1800	932	1058	2736	-	RBCB	1122	2800	-	5086902
6CP3-2000	2000	1045	1120	3001	-	5109936	1191	3072	-	5087359
6CP3-2200	2200	1158	1184	3268	-	5110036	1260	3344	-	5079733
6CP3-2400	2400	1270	1247	3533	-	RBCB	1333	3619	-	LAR
6CP3-2500	2500	1330	1278	3672	-	5147936	1367	3761	-	LAR

STANDARD TOOLS

Morin Original system coupler M6 for machines from 15t to 24t
Couplers available on pages 18 to 30

As a bucket isn't always enough, a range of TOOLS is available to meet all your needs. For more information, please refer to the attached product specification sheets or contact us.

(*) Weight variation of +/- 2% depending on equipment | Stock item ■

Ripper tooth

Ripper tooth for work on rocky terrain
R = 1,237 80 mm 1 tooth ESCO U40P



PART NUMBER	WEIGHT (kg)*	PRICE EXCL. VAT (€)
5074866	315	-

Universal joint

Tool for articulating, along two axes, a gripper, a grapple, an auger, etc.



PART NUMBER	WEIGHT (kg)*	PRICE EXCL. VAT (€)
UNIVERSAL JOINT-M6	Depending on equipment	-

Suspension link

Tool for single-axis articulation of products already fitted with a suspension system



PART NUMBER	WEIGHT (kg)*	PRICE EXCL. VAT (€)
NOIX-M6	Depending on equipment	-

4 x 1 bucket

Multi-purpose tool enabling various operations to be carried out with a single tool, such as: loading, snow removal, levelling, etc.

Dimensions:

- Width 1870 mm,
- 700 l capacity



PART NUMBER	WEIGHT (kg)*	PRICE EXCL. VAT (€)
4x1-M6	787	-

Bolt-on adapter

Tool for bolting on hydraulic equipment



PART NUMBER	WEIGHT (kg)*	PRICE EXCL. VAT (€)
BOLT-ON ADAPTER-M6	Depending on equipment	-

Pallet forks

There are two versions of our pallet forks:

- A simple version, for attachment using a quick coupler only.
- A version with an arrangement on the front blade, allowing the pallet forks to be attached to the blade, for use on sites only.

To order your pallet forks, please specify which version you require. For the second version, the decision to weld or place depends on the blade profile of your machine. Forks 3,000 kg.



PART NUMBER	WEIGHT (kg)*	PRICE EXCL. VAT (€)
LP-M6-SIMPLE	530	-
LP-M6-SUR LAME	540	-

SPECIAL TOOLS

Morin Original system coupler M6 for machines from 15t to 24t
Couplers available on pages 18 to 30

Non-exhaustive list. Please contact us for more information.

Some situations require special dimensions or configurations. That's why ACB+ is at your disposal for any specific requests. Our SPECIAL TOOLS are made to measure. So you have a choice of teeth, pitch, width, etc. Here are just a few examples.

(*) Weight variation of +/- 2% depending on equipment

Grid backhoe

Tool for sieving rubble and pebbles.
Grid backhoe 1,400 mm
5 teeth FUTURA FT290S - Pitch 100 x 200 mm



PART NUMBER	WEIGHT (kg)*	PRICE EXCL. VAT (€)
5091832	979	-

Skeleton grid ditch cleaning bucket

Tool for screening, grading and recycling rubble on site
Skeleton grid ditch cleaning bucket 3,000 mm
16 teeth JCB 531-03205D - Pitch 40 x 80 mm



PART NUMBER	WEIGHT (kg)*	PRICE EXCL. VAT (€)
5100023	611	-

Universal grading bucket

Finishing tool for rotating couplers and tiltrotators
Universal grading bucket 1700 mm
RBCB - 0.98m3 - Profile 6UP



PART NUMBER	WEIGHT (kg)*	PRICE EXCL. VAT (€)
5152505	853	-

Claw backhoe

Tool for gripping and manipulating objects - Claw backhoe
1,400 mm 1.3m3 -
7 Teeth CAT J352 1U3352



PART NUMBER	WEIGHT (kg)*	PRICE EXCL. VAT (€)
5106868	1511	-

SPECIAL TOOLS

Morin Original system coupler M6 for machines from 15t to 24t
Couplers available on pages 18 to 30

(*) Weight variation of +/- 2% depending on equipment

Rear rake

Tool for small-scale forestry work to rake, swath and load stumps and branches

Rear Rake 2,200 mm -
8 teeth ESCO U30S - Pitch 198 m



PART NUMBER	WEIGHT (kg)*	PRICE EXCL. VAT (€)
5100667	1006	-

Grapple thumb

Hydraulic tool mounted directly under the dipperstick of an excavator to help pick up and place objects.

Thumb Module 6



PART NUMBER	WEIGHT (kg)*	PRICE EXCL. VAT (€)
THUMB-M6	Depending on equipment	-

Front and rear rake

A tool for small-scale forestry work to create swaths by pulling and pushing. Front and Rear Rake 2,000 mm 7 Claws - Pitch 300 mm



PART NUMBER	WEIGHT (kg)*	PRICE EXCL. VAT (€)
5075120	1396	-

Stump grinder tooth

Tool for levelling (cutting) stumps and completing stump removal

Stump grinder -
R = 996 mm - 80 mm Double



PART NUMBER	WEIGHT (kg)*	PRICE EXCL. VAT (€)
5075724	322	-

TRAPEZOIDAL BUCKETS

Morin Original system coupler M6
for machines from 15t to 24t
Couplers available on pages 18 to 30

TRAPEZOIDAL BUCKETS have been designed for creating, cleaning and finishing ditches. To adapt to all types of terrain and configurations, numerous variants are available. For more information, please refer to the attached product specification sheets or contact us.

Trapezoidal buckets with 45° angles

Buckets for creating profiled ditches - with teeth.
Angle: 45° (1 for 1)

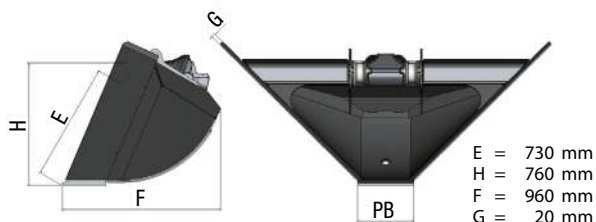

Profile 1

SMALL LOW (mm)	ITEM CODE	PRICE EXCL. VAT (€)
400	TC-6-P1-45-400	-
500	TC-6-P1-45-500	-
600	TC-6-P1-45-600	-



Profile 2

SMALL LOW (mm)	ITEM CODE	PRICE EXCL. VAT (€)
350	TC-6-45-350	-
400	TC-6-45-400	-
450	TC-6-45-450	-
500	TC-6-45-500	-
550	TC-6-45-550	-

Trapezoidal buckets with 33° angles

Buckets for creating profiled ditches - with teeth.
Angle: 33° (3 for 2)

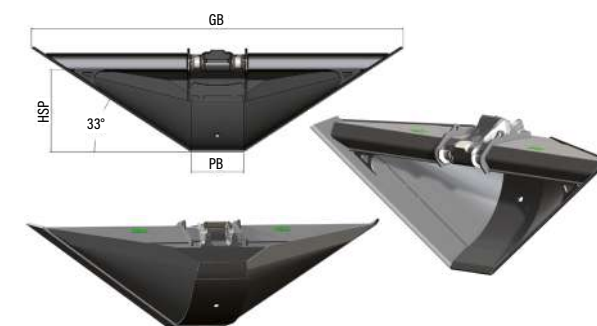

SMALL LOW (mm)	ITEM CODE	PRICE EXCL. VAT (€)
350	TC-6-33-350	-
400	TC-6-33-400	-
450	TC-6-33-450	-
500	TC-6-33-500	-
550	TC-6-33-550	-

TRAPEZOIDAL BUCKETS

Morin Original system coupler M6
for machines from 15t to 24t
Couplers available on pages 18 to 30

(*) Weight variation of +/- 2% depending on equipment

Reprofiling trapezoidal bucket - Wide angle

Buckets for creating profiled ditches - without teeth.



LARGE LOW (mm)	SMALL LOW (mm)	PRICE EXCL. VAT (€)
	200	-
	300	-
from 800 mm to 1,500 mm	400	-
	450	-
	500	-

Reprofiling trapezoidal bucket - Narrow angle

Buckets for creating profiled ditches - without teeth.

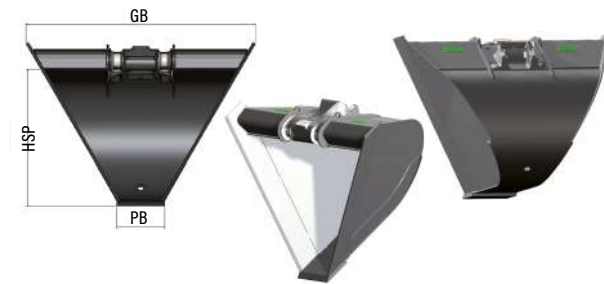

LARGE LOW (mm)	SMALL LOW (mm)	PRICE EXCL. VAT (€)
	200	-
	300	-
from 1,550 mm to 3,000 mm	400	-
	450	-
	500	-

Special trapezoidal bucket

Buckets for creating profiled ditches - without teeth.

Dimensions:

- Large base (GB) = 1,400 mm
- Beam height (HSP) = 700 mm
- Small base (PB) = 0 mm

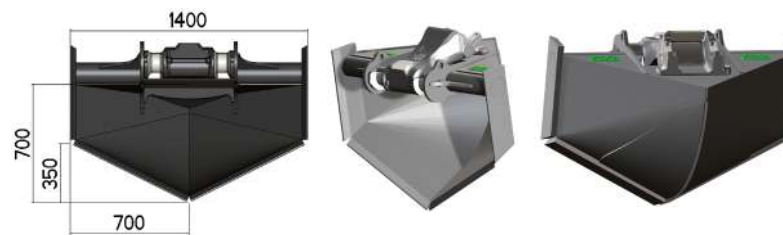

ITEM CODE	WEIGHT (kg)	PRICE EXCL. VAT (€)
5070461	485	-

ROTATING TRAPEZOIDAL BUCKETS

Morin Original system coupler M6
for machines from 15t to 24t
Couplers available on pages 18 to 30

TRAPEZOIDAL BUCKETS have been designed for creating, cleaning and finishing ditches. To adapt to all types of terrain and configurations, numerous variants are available. For more information, please refer to the attached product specification sheets or contact us.

Rotating reprofiling trapezoidal buckets 2x45° wide angle

Buckets for reprofiling ditches - Toothless

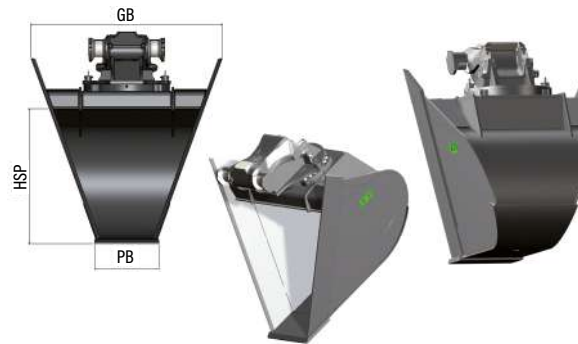

LARGE LOW (mm)	SMALL LOW (mm)	PRICE EXCL. VAT (€)
from 1,000 mm to 1,500 mm	200	-
	300	-
	400	-
	450	-
	500	-

Rotating reprofiling trapezoidal buckets 2x45° narrow angle

Buckets for reprofiling ditches - Toothless

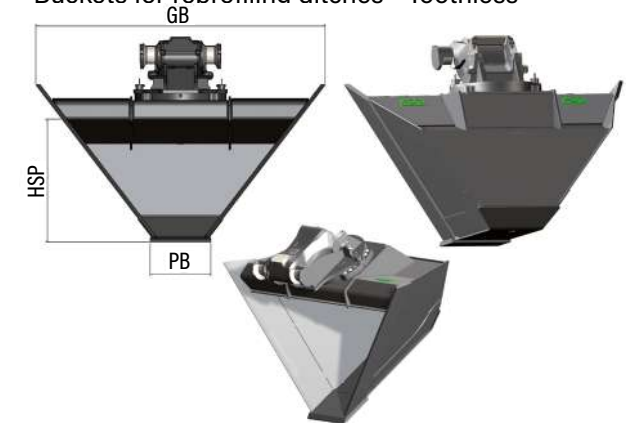

LARGE LOW (mm)	SMALL LOW (mm)	PRICE EXCL. VAT (€)
from 1,550 mm to 2,000 mm	200	-
	300	-
	400	-
	450	-
	500	-